

JVC®

V.NETWORKS

Model **VN-C10**

INSTRUCTIONS

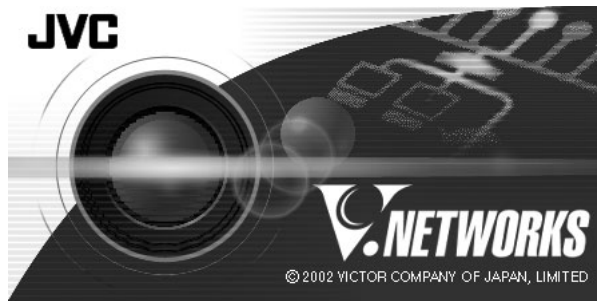

For Customer Use:

Enter below the Serial No. which is located on the body. Retain this information for future reference.

Model No. **VN-C10** _____

Serial No. _____

IMPORTANT SAFEGUARDS

1. Read all of these instructions.
2. Save these instructions for later use.
3. All warnings on the product and in the operating instructions should be adhered to.
4. Unplug this appliance system from the wall outlet before cleaning. Do not use liquid cleaners or aerosol cleaners. Use a damp cloth for cleaning.
5. Do not use attachments not recommended by the appliance manufacturer as they may cause hazards.
6. Do not use this appliance near water - for example, near a bathtub, washbowl, kitchen sink, or laundry tub, in a wet basement, or near a swimming pool, etc.
7. Do not place this appliance on an unstable cart, stand, or table. The appliance may fall, causing serious injury to a child or adult, and serious damage to the appliance. Use only with a cart or stand recommended by the manufacturer, or sold with the appliance. Wall or shelf mounting should follow the manufacturer's instructions, and should use a mounting kit approved by the manufacturer. An appliance and cart combination should be moved with care. Quick stops, excessive force, and uneven surfaces may cause the appliance and cart combination to overturn.
8. Slots and openings in the cabinet and the back or bottom are provided for ventilation, and to insure reliable operation of the appliance and to protect it from overheating, these openings must not be blocked or covered. The openings should never be blocked by placing the appliance on a bed, sofa, rug, or other similar surface.
This appliance should never be placed near or over a radiator or heat register. This appliance should not be placed in a built-in installation such as a bookcase unless proper ventilation is provided.
9. This appliance should be operated only from the type of power source indicated on the marking label. If you are not sure of the type of power supplied to your home, consult your dealer or local power company. For appliance designed to operate from battery power, refer to the operating instructions.
10. This appliance system is equipped with a 3-wire grounding type plug (a plug having a third (grounding) pin). This plug will only fit into a grounding-type power outlet. This is a safety feature. If you are unable to insert the plug into the outlet, contact your electrician to replace your obsolete outlet. Do not defeat the safety purpose of the grounding plug.
11. For added protection for this product during a lightning storm, or when it is left unattended and unused for long periods of time, unplug it from the wall outlet and disconnect the antenna or cable system. This will prevent damage to the product due to lightning and power-line surges.
12. Do not allow anything to rest on the power cord. Do not locate this appliance where the cord will be abused by persons walking on it.
13. Follow all warnings and instructions marked on the appliance.
14. Do not overload wall outlets and extension cords as this can result in fire or electric shock.
15. Never push objects of any kind into this appliance through cabinet slots as they may touch dangerous voltage points or short out parts that could result in a fire or electric shock. Never spill liquid of any kind on the appliance.
16. Do not attempt to service this appliance yourself as opening or removing covers may expose you to dangerous voltage or other hazards. Refer all servicing to qualified service personnel.
17. Unplug this appliance from the wall outlet and refer servicing to qualified service personnel under the following conditions:
 - a. When the power cord or plug is damaged or frayed.
 - b. If liquid has been spilled into the appliance.
 - c. If the appliance has been exposed to rain or water.
 - d. If the appliance does not operate normally by following the operating instructions. Adjust only those controls that are covered by the operating instructions as improper adjustment of other controls may result in damage and will often require extensive work by a qualified technician to restore the appliance to normal operation.
 - e. If the appliance has been dropped or the cabinet has been damaged.
 - f. When the appliance exhibits a distinct change in performance - this indicates a need for service.
18. When replacement parts are required, be sure the service technician has used replacement parts specified by the manufacturer that have the same characteristics as the original part. Unauthorized substitutions may result in fire, electric shock, or other hazards.
19. Upon completion of any service or repairs to this appliance, ask the service technician to perform routine safety checks to determine that the appliance is in safe operating condition.



PORTABLE CART WARNING
(symbol provided by RETAC)



S3125A

Safety Precautions

FOR USA AND CANADA

	CAUTION RISK OF ELECTRIC SHOCK DO NOT OPEN	
CAUTION: TO REDUCE THE RISK OF ELECTRIC SHOCK, DO NOT REMOVE COVER (OR BACK). NO USER-SERVICEABLE PARTS INSIDE. REFER SERVICING TO QUALIFIED SERVICE PERSONNEL.		



The lightning flash with arrowhead symbol, within an equilateral triangle is intended to alert the user to the presence of uninsulated "dangerous voltage" within the product's enclosure that may be of sufficient magnitude to constitute a risk of electric shock to persons.



The exclamation point within an equilateral triangle is intended to alert the user to the presence of important operating and maintenance (servicing) instructions in the literature accompanying the appliance.

Information for USA

This device complies with part 15 of the FCC Rules. Changes or modifications not approved by JVC could void the user's authority to operate the equipment.

This equipment has been tested and found to comply with the limits for a Class A digital device, pursuant to Part 15 of the FCC Rules. These limits are designed to provide reasonable protection against harmful interference when the equipment is operated in a commercial environment. This equipment generates, uses, and can radiate radio frequency energy and, if not installed and used in accordance with the instruction manual, may cause harmful interference to radio communications. Operation of this equipment in a residential area is likely to cause harmful interference in which case the user will be required to correct the interference at his own expense.

This device complies with Part 15 of the FCC Rules. Operation is subject to the following two conditions: (1) This device may not cause harmful interference, and (2) this device must accept any interference received, including interference that may cause undesired operation.

Due to design modifications, data given in this instruction book are subject to possible change without prior notice.

WARNING:

TO REDUCE THE RISK OF FIRE OR ELECTRIC SHOCK, DO NOT EXPOSE THIS APPLIANCE TO RAIN OR MOISTURE.

AVERTISSEMENT:

POUR EVITER LES RISQUES D'INCENDIE OU D'ELECTROCUTION, NE PAS EXPOSER L'APPAREIL A L'HUMIDITE OU A LA PLUIE.

INFORMATION (FOR CANADA) RENSEIGNEMENT (POUR CANADA)

This Class A digital apparatus complies with Canadian ICES-003.

Cet appareil numérique de la Class A est conforme à la norme NMB-003 du Canada.

Information for Europe Warning:

This is a class A product. In a domestic environment this product may cause radio interference in which case the user may be required to take adequate measures.

Thank you for purchasing this product.

(These instructions are for VN-C10U.)

Before beginning to operate this unit, please read the instruction manual carefully in order to make sure that the best possible performance is obtained.

Contents

Introduction

Contents	4
Features	6
Items Included	6
Required Operating Environment	7
Upgrading the Application	7
Operating Precautions	8
Controls, Connectors and Indicators	9

Preparations

Connection Examples	11
Preparation Procedure	12

Step 1 Connection and Installation

1-1 Attaching a Lens	13
1-2 Connecting the Power Cord	14
1-3 Connecting a LAN Cable	15
1-4 Connecting the Alarm I/O Terminals	16
1-5 Installing the Camera	18

Step 2 Setting the Network

2-1 Installing the Software	19
2-2 Setting the PC's IP Address for Windows XP	20
Setting the PC's IP Address for Windows 2000	22
2-3 Setting the IP Address for VN-C10 with V.Networks Setup Tool	24
2-4 Other Settings with V.Networks Setup Tool	26
1 Password Setting	27
2 Alarm Setting	28
3 Motion Detection Setting	30
4 Recording Setting	32
5 FTP Client Setting	34
6 Multicast	36
7 Compression Format	38
8 Memory Capacity	38
9 Web	39
10 FTP Server	40
11 Time Setting	41
2-5 Registering the Connected Camera with V.Networks Controller	42

Step 3 Adjusting the Camera

3-1 Back-focus Adjustment	43
---------------------------------	----

**Operations
(V.Networks
Controller)**

Step 4 Setting with V.Networks Controller

4-1	Starting Up V.Networks Controller	44
4-2	Function Settings with V.Networks Controller	45
4-3	Motion Detection Standby	46
4-4	Image Size and Inversion	47
4-5	Setting the Image Quality	48
4-6	Frame Rate	50
4-7	Alarm Setting	51
4-8	Time Stamp	53
4-9	Changing the Registered Information	54

Step 5 Operations with V.Networks Controller

5-1	Operations with V.Networks Controller	55
5-2	Record/Stop	56
5-3	Playback	57
5-4	Other Instructions on Record and Playback	59
5-5	Snapshot	60

**Operations
(Web Browser)**

Step 6 Operations with a Web Browser

6-1	Required Operating Environment	61
6-2	Access Authorization	62
6-3	Starting Up the Web Browser	63
6-4	Settings with a Web Browser	64
1	Other Settings	65
2	Image Settings	68
3	View Settings	69
4	Alarm Settings	70
5	FTP Settings	71
6-5	Viewing Still Images	73
6-6	Viewing Moving Images	74
6-7	VN-C10 Image Link	75

Others

Troubleshooting	76
Specifications	77
External Dimensions	77

Introduction

Features

- VN-C10 uses a 1/3-inch CCD with 380,000 pixels, enabling monitoring of high quality images.
- For the compression method, in addition to the standard JPEG, VN-C10 supports MPEG4 for a wide range of bit rates. (With MPEG4, up to 4 clients can be connected at one time.)
- Equipped with an image recording function by motion detection and alarm input.
- VN-C10 has a design similar to other CCTV monitoring cameras, allowing peripheral equipment for such cameras to be also used for VN-C10.
- With a built-in Web server, VN-C10 supports Internet Explorer and Netscape.
- Multicast function. (Only for JPEG)

Items Included

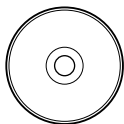

CD-ROM

(The Instruction Manual inside)



Read Me First



Warranty Card



Service Information Card

How to Use This Manual

Characters and Symbols used in this Manual

Caution

Operational points special attention should be paid to, because of, for example, danger involved.

Note

Functional or operational tips.



Pages or items to refer to.

※ In no case, shall JVC be held liable for any loss or damage to the customer or for any claim from any third party arising from using this software.

For the purpose of improving the product, the software specifications are subject to change without prior notice.

The product names that appear in this document are brand names or registered trademarks of each relevant company. Marks and symbols such as TM, ® and © do not appear in this document.

Required Operating Environment

PC Specifications

OS	: Windows 2000 (Service Pack 1 or higher) Windows XP Home Edition Windows XP Professional
CPU	: Pentium III 500 MHz or higher (1 GHz or higher recommended)
Memory Capacity	: 128 MB or more
Hard Disk Space	: 20 MB or more
Display/Video Card	: 1024 X 768 pixels or more, True Color (24 bits or 32 bits)

LAN Specifications

- 10 BASE-T/100 BASE-TX network connected with IEEE802.3 hubs.

Note

The PC specifications above are only for a reference purpose. They are not meant to guarantee a smooth operation of the application software. Depending on the usage of the PC, there may be cases where problems occur even if the PC satisfies the technical requirements.

Caution

If the OS specifications of the PC to be used are higher, they precede those described above.

Upgrading the Application

For information on upgrading the application, visit the following website.
<http://www.jvc-victor.co.jp/english/pro/vnetworks/index-e.html>

Introduction

Operating Precautions

- VN-C10 is designed for indoor use. For outdoor use, prepare a proper housing to cover and protect the camera.
- The product should not be installed or used in the following locations.
 - Locations subject to rain or water.
 - Locations with hot air or oil vapors such as in kitchens, etc.
 - Locations where the allowed ambient temperature (0 °C to 40 °C) is exceeded.
 - Locations exposed to X-ray radiation or where strong electrical or magnetic waves are generated.
 - Locations where corrosive gas is generated.
 - Locations with vibrations.
 - Locations with excessive dust.
- If VN-C10 and the cables connected to VN-C10 are installed at a location where strong electrical or magnetic waves are generated, near a radio, TV set, transformer, motor etc., the quality of image and color may be affected.
- If a high-intensity object (such as a lamp) is shot, the image on the screen may have vertical lines (smear) or blur (blooming) at its periphery. This is a characteristic of the CCD, and is not a defect.
- Clean the unit with the power turned off. Use a soft cloth like cotton flannel to wipe out dirt. Do not use paint thinner or benzine as a cleaning agent as this may cause melting or tarnishing of the unit surface. If dirt is persistent, use a cloth soaked with water-diluted mild detergent and then wipe it with a dry cloth.
- Because the cable holders of the terminals could come loose, perform cable connection carefully and securely.
- Insufficient dissipation of heat from the unit may cause damage. Use the unit at a well-ventilated location. In particular, do not block the unit's cooling-fan ventilation opening.
- In a narrowband environment, for example, of dial-up connection, smooth running of MPEG4 images cannot be obtained. This is due to the product design, therefore not a defect.
- When this product is installed in an NAT environment, MPEG4 images cannot be viewed. This is due to the product design, therefore not a defect. (This product uses a network protocol called RTP for transmitting MPEG4 images. Generally, an NAT router cannot carry out NAT translation of RTP packets properly.)
- Certain hubs and switches equipped with SNMP functions have a broadcast or multicast control function. If the function is enabled, multicast images created by this product may not be viewed properly.
- To save electricity, turn off the power to the system when not in use.
- **As local recording images are saved to the volatile memory of the product, the images are deleted if the power is turned off. (☞ Page 33)**

Controls, Connectors and Indicators

(Front, top and side views)

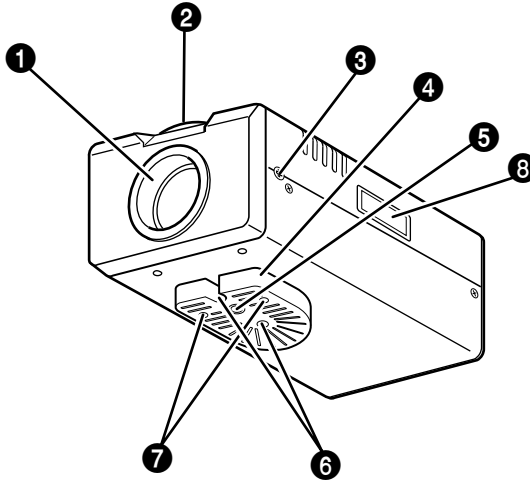

❶ Lens mount

The mount for attaching a lens. Either a C-mount or a CS-mount lens can be used.

❷ Back-focus adjustment ring

The ring for adjusting back-focus and changing the mount method. For adjusting back-focus or changing the mount method, loosen the back-focus locking screw (❸) by turning it counterclockwise and, after the operation, fix it by turning it clockwise. At the factory, VN-C10 is optimized for attaching a CS mount lens.

❸ [BF LOCK] locking screw

This serves to fix the back focus-adjustment ring.

❹ Bracket for camera mounting.

At the factory, the bracket is attached on the bottom of the camera. According to the installation condition, this can be attached at the top. Use the screws (❺) for attaching the bracket to the camera.

❺ Screw hole (1/4-20UNC)

For attaching the camera to a fixer or a pan/tilt unit. The screw length must not exceed 7 mm. If a longer screw is used, the internal parts of the camera may be damaged.

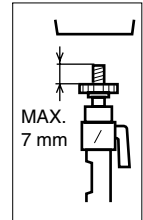

❻ Fall-preventive holes

For installing the camera securely, use these holes to prevent it from falling off.

❼ Screws for the bracket (x 2: M2.6 X 6 mm)

Screws of the length of 6 mm should be used. A longer screw may damage the internal parts.

❽ [MAC address]

Physical address unique to the unit. Cannot be changed.

Introduction

Controls, Connectors and Indicators (continued)

(Side and rear views)

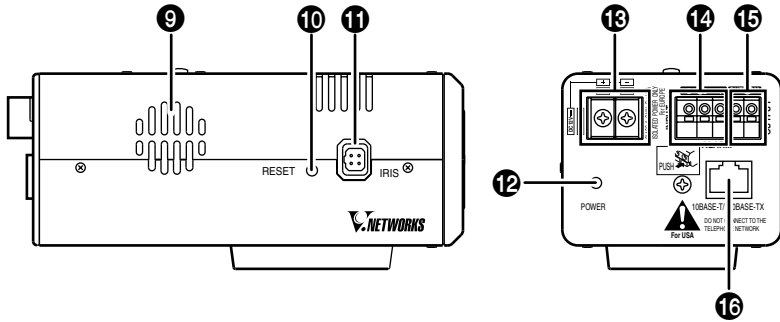

9 Ventilation opening

For the internal cooling fan. Install the camera in a way that does not cover the opening.

10 [RESET] button

Press this button to reset VN-C10. If this button is held down for 2 seconds or longer, the values set with [V.Networks Setup Tool] return to those set at the factory, and VN-C10 restarts.

11 [IRIS] terminal

For connecting with a DC IRIS lens.
(A video iris lens cannot be connected.)

12 [POWER] indicator

This indicator starts blinking when the power is turned on. When the camera is ready for network connection, this becomes steady on. If the indicator blinks while the camera is in use, check the camera and/or the network equipment.

13 [DC 12 V/AC 24 V] Power terminal

For connecting to a DC 12 V or AC 24 V, 50 Hz/60 Hz, power source. (☞ Page 14)

14 [ALARM INPUT] terminals

For connecting with an external alarm equipment. (☞ Page 16)

15 [ALARM OUTPUT] terminals

For connecting with an external alarm equipment. (☞ Page 16)

16 [10 BASE-T/100 BASE-TX]

For network connection with a LAN cable.
(☞ Page 15)

Preparations

Connection Examples

LAN Connection

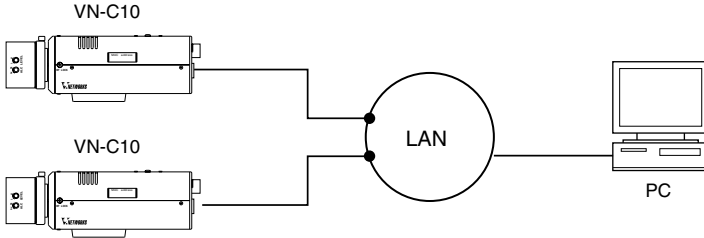

Network Connection

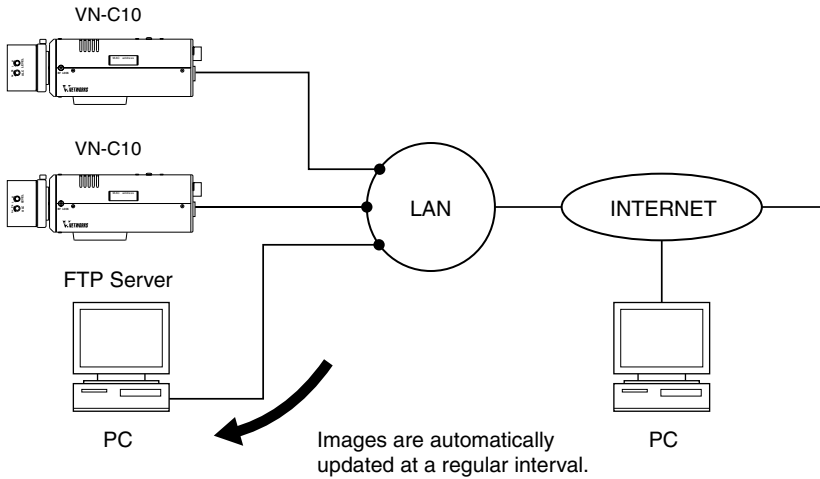

Peer-to-Peer Connection

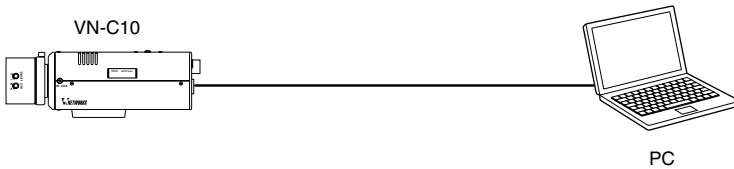

Preparations

Preparation Procedure

Set the camera in the following procedure.

Step 1 Connection and Installation

Attach a lens and connect the power cable, a LAN cable and an alarm etc. Then, install the camera to a fixer, etc. Fix a wire securely for preventing the camera from falling off.

 Page 13



Step 2 Setting the Network

Install the software [V.Networks Controller], and set the network for the PC and VN-C10. Also perform the setting with [V.Networks Setup Tool] and registration of the connected camera with [V.Networks Controller].

 Page 19



※ If multiple PCs are in use, first turn on the power for one PC and proceed to 2-4 Other Settings with V.Networks Setup Tool. Only then, turn on the power to a second PC and go on to 2-4. Repeat the procedure for other PCs. ( Page 14)

Step 3 Adjusting the Camera

Adjust the back-focus while checking images.

 Page 43



Step 4 Setting with V.Networks Controller

Set image quality and alarm, etc. by using [V.Networks Controller] which has been installed.

 Page 44



Step 5 Operations with V.Networks Controller

Now the camera is ready for recording and playback, etc. with [V.Networks Controller].

 Page 55



Step 6 Operations with a Web Browser

The camera is ready for Web operations.

 Page 61

Preparations (Step 1 Connection and Installation)

1-1 Attaching a Lens

Attach a lens in the following procedure.

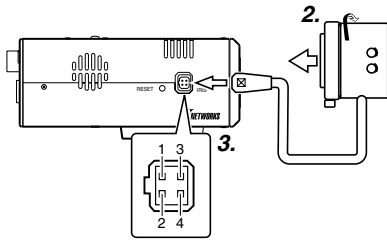
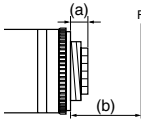
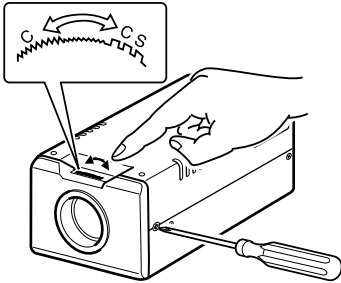

1. Before attaching a lens, check the mount method of the lens.

VN-C10 is set for CS-mount at the factory. For attaching a C-mount lens, loosen the back-focus locking screw using a screwdriver and turn the back-focus adjustment ring to change the mount method accordingly with a finger or a pointed tool like a screwdriver.

To attach a lens, observe the length shown as (a). Do not use a lens with a length longer than (a) as it may cause damage to the internal parts of the camera and proper lens attachment would not be possible.

Lens	Flange-back distance (b)	Length (a)
C-mount lens	17.526mm	10 mm max.
CS-mount lens	12.5mm	5.5 mm max.

2. Attach the lens to the camera securely by turning it clockwise.

3. In the case of a DC IRIS lens, connect the lens cable to the socket while examining the pin arrangement.

4-Pin Plug

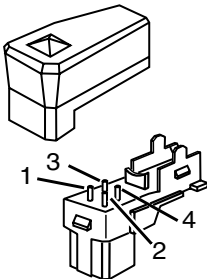

Pin No.	Lens	DC IRIS Lens (Without a built-in EE amplifier)
1		Damping ⊖
2		Damping ⊕
3		Driving ⊕
4		Driving ⊖

Preparations (Step 1 Connection and Installation)

1-2 Connecting the Power Cord

Connect the camera to DC 12 V or AC 24 V.

The power indicator is lit when the power is turned on.

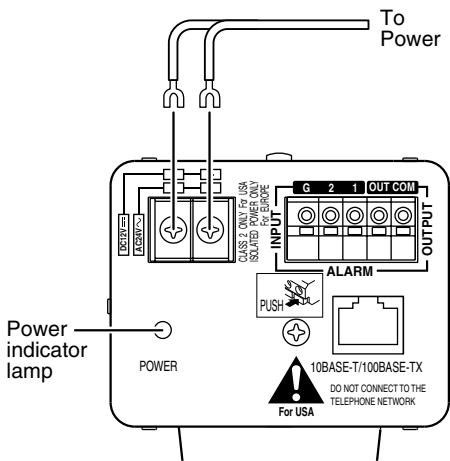

Power Cord

- Do not connect the power cord to DC 12 V and AC 24 V at the same time.
- Use a lug plate to securely connect the power cord to the power terminals and avoid misconnection or loose connection.
- For DC 12 V connection, ensure that the polarities, positive and negative, are correctly oriented.
- For DC 12 V connection, the ripple voltage should not exceed 50 mV.

Length: 30 m maximum
UL1007, UL1015 or equivalent
AWG #20 or equivalent, or higher

WARNING

Connect with the appropriate power-supply voltage. The rated voltage for VN-C10 is DC 12 V or AC 24 V, 50 Hz/60 Hz. If a voltage exceeding the rating is supplied, malfunction, or in the worst case, fuming or fire, may be caused.

For AC 24 V, ensure that the primary side is insulated with the secondary one.

For a system with multiple VN-C10s

In a system where more than one VN-C10 are used, turn on the power for a VN-C10 first and proceed the setting to 2-4 Other Settings with V.Networks Setup Tool. Only then turn on the power for a second one and go on to 2-4. Repeat the procedure for the other cameras.

Note

The IP address of VN-C10 is set to "198.168.0.2" at the factory. Proper access cannot be established due to IP address redundancy if the power is turned on for multiple cameras at one time under a single LAN environment. **Do not turn on the power for multiple cameras at the same time.** If an IP address redundancy occurred, ensure that only one VN-C10 exists on a single LAN environment and wait for some time (at least 10 minutes). Or turn off the power once for all network equipment and turn it on again for proper access to VN-C10.

1-3 Connecting a LAN Cable

Connect the camera to a hub or a PC by using a LAN cable.

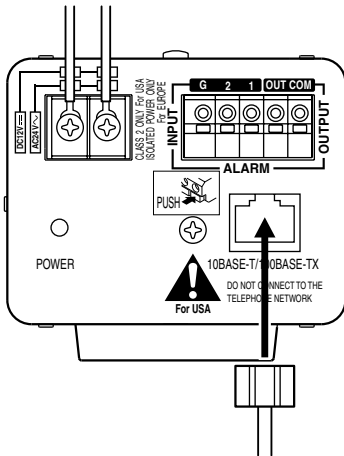

- **For hub connection**
Use a straight cable.
- **For PC connection**
Use a cross-over cable.

Caution

There are a few types of LAN board for which a cross-over cable cannot be used. Check the specifications of the LAN board to be used before performing connection.

Note

For 100 BASE-TX, use a CAT-5 cable.

Preparations (Step 1 Connection and Installation)

1-4 Connecting the Alarm I/O Terminals

Connect the alarm I/O terminals with external equipment such as a sensor, buzzer, etc.

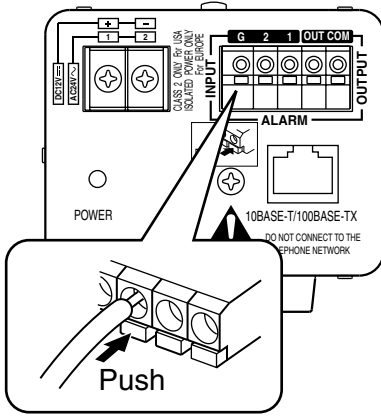

Press the buttons for connecting or disconnecting cables as shown on the left.

Cable Specifications

50 m max.

UL1007, UL1015 or equivalent

AWG #22 to AWG #18 or equivalent

Caution

Due to external noise, the camera may not work properly even if the length of the cable is less than 50 m. If this occurs, use a shielded cable or keep the cable away from the noise source.

Alarm Input Terminal

This terminal is for connecting with a sensor, infrared, door or metallic, or a manual switch.

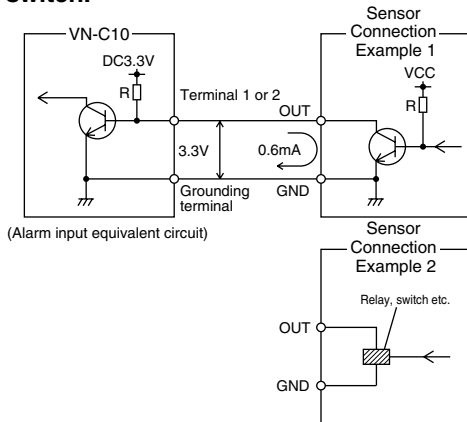

Input Requirements

- No-voltage relay “A-contact” input or NPN open collector input
(A-contact: Contact is normally open and closes when the alarm is turned on.)
- Active low level
- Latch/Momentary (at least 500 ms)
- Circuit current at low level: 0.6 mA
- Voltage applied at high level: 3.3 V

1-4 Connecting the Alarm I/O Terminals (continued)

Alarm Output Terminal

This terminal is for connecting with an alarm annunciator such as an indicator, a lamp or a buzzer.

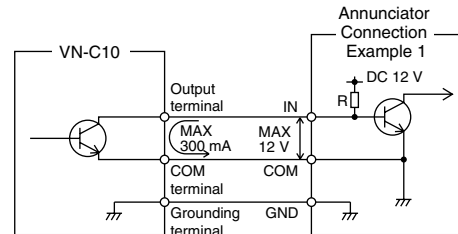

(Alarm output equivalent circuit)

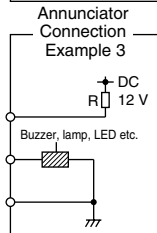
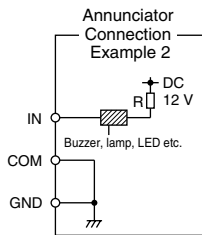

Output Requirements

- Equivalent to NPN open collector output (The output logic is set with [V.Networks Setup Tool.])
- Allowed applied voltage: DC 12 V max.
- Allowed input current: 300 mA
- Momentary output: 2 to 5000 ms (The duration is set with [V.Networks Setup Tool.])

Caution

Connect the VN-C10 grounding terminal to the one of the annunciator.

Preparations (Step 1 Connection and Installation)

1-5 Installing the Camera

Fall-Preventive wire

For attaching the camera to a fixer or a rotating platform, use the screw hole of the mounting bracket.

Camera mounting screw hole Camera-mounting bracket

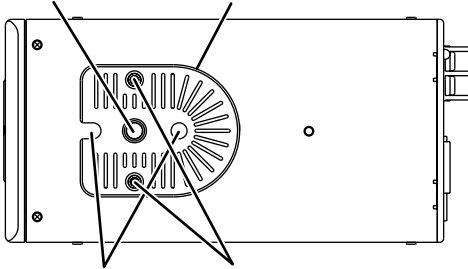

Fall-preventive holes Screws for the bracket
[x 2: M2.6 x 6 mm]

Securing wire

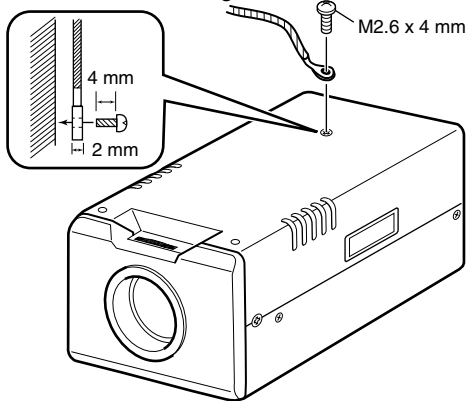

Caution

- The length of the screw for mounting the camera must not exceed 7 mm. Do not use a longer screw as it may damage the internal parts of the camera.
- In the factory setting, the bracket is attached on the top of the camera. For attaching it at the bottom, remove the two screws fixing the bracket.

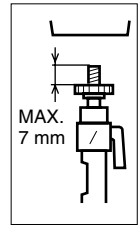

Caution

For fixing the bracket, screws of the length of 6 mm should be used. Do not use a longer screw as it may damage the internal parts of the camera.

[Fall Prevention]

WARNING

- Special care is required if the camera is installed on a wall or ceiling. You should not attempt to install it by yourself as it may cause injury or an accident. This installation work should be carried out only by qualified and experienced personnel.
- When the camera is attached to a fixer or a pan/tilt unit, use the holes for fall prevention to secure it.
- To prevent the camera from falling off, secure it to a secure and stable structure such as a ceiling slab or a channel by using a wire.
- Ensure that the length, strength, routing and material (insulation) of the securing wire to be used are appropriate.
- To attach the securing wire, use the black screw on the top side of the camera.
- For fixing the wire, a screw of M2.6 X 4mm should be used. Do not use a longer screw as it may damage the internal parts of the camera.

Preparations (Step 2 Setting the Network)

2-1 Installing the Software

For operating VN-C10, install the software from the CD-ROM, which is supplied with the camera in the following procedure.

Installing V.Networks Controller

1. Select [Setup.exe] found in the [JVC] folder.
2. Proceed by following the instructions shown on the screen.
3. If the installation is successfully executed, the [V.Networks] icon is created in [Programs] of the Windows [Start] menu.  [V.Networks Controller] is displayed in [V.Networks].

Installing V.Networks Setup Tool

1. Open the [JVC] folder and then the "setup" folder inside. Select [Setup.exe].
2. Proceed by following the instructions shown on the screen.
3. If the installation is successfully executed, the [V.Networks] icon is created in [Programs] of the Windows [Start] menu.  [vn-c10u Setup Tool] is displayed in [V.Networks].

Installing DirectX 8.1 and Codec

[DirectX 8.1] and ISO MPEG4 Codec are required for viewing MPEG4 images with VN-C10. If the version currently installed in the PC is older, install the version 8.1 by following the procedure below.

Installing Codec

Select [WMPCD8.exe] and install Codec by following the instructions shown on the screen.

Installing DirectX 8.1

1. Click [Start] and select [Run]. And enter [dxdiag] in the box and click [OK].
2. If the version is older, select [DX81NTeng.exe] and follow the instructions on the screen.

Preparations (Step 2 Setting the Network)

2-2 Setting the PC's IP Address for Windows XP

After attaching the camera, proceed to set the IP address of the PC by which the camera is operated.

With Windows XP, follow the procedure below to set the IP address.

(For Windows 2000,  Page 22)

Note

Under a DHCP environment and also if the IP address to be allotted to [V.Networks] is already known, skip 2-2 [Setting the PC's IP Address].

1. Click .

- Right-click [My Network] and select [Properties].

2. Select the network connected to the PC by which VN-C10 is operated.

- Right-click to select [Properties].

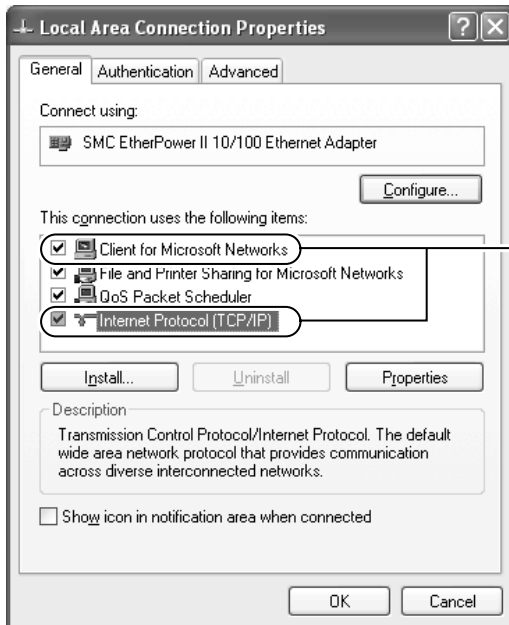

Ensure that [Client for Microsoft Networks] is selected .

Note

If either [Client for Microsoft Networks] or [Internet Protocol (TCP/IP)] is not displayed, select [Install ...].

2-2 Setting the PC's IP Address for Windows XP (continued)

3. Select [Internet Protocol (TCP/IP)] and click [Properties].

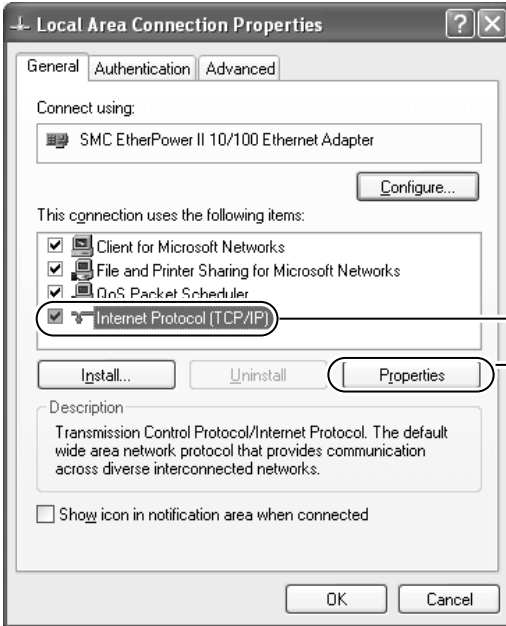

① Select [Internet Protocol (TCP/IP)].

② Click [Properties].

4. Select [Use the following IP address] to set [IP Address] and [Subnet Mask] and then click

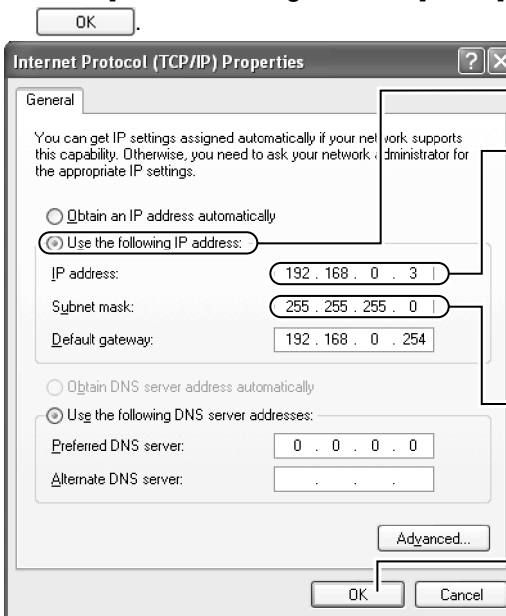

① Select [Use the following IP address].

② Set [IP Address] to "192.168.0.3".

③ Set [Subnet Mask] to an appropriate value according to the operating environment. Ask the network administrator if necessary.

④ Click [OK].

5. Click [OK] in [Local Area Connection Properties].

Note

- Before changing the IP address, note down the original address.
- Do not use the same IP address elsewhere in this network environment.

Preparations (Step 2 Setting the Network)

2-2 Setting the PC's IP Address for Windows 2000

After attaching the camera, proceed to set the IP address of the PC by which the camera is operated.

With Windows 2000, follow the procedure below to set the IP address.

1. Click [Start].

Select [Settings] and click [Control Panel].

2. Double-click [Network and Dial-up Co...].

3. Double-click [Local Area Connection].

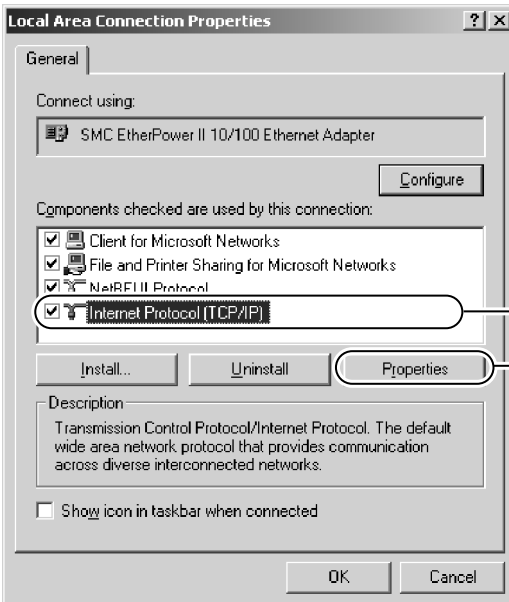

① Select [Internet Protocol (TCP/IP)].

② Click [Properties].

2-2 Setting the PC's IP Address for Windows 2000 (continued)

4. Click [IP Address] in [TCP/IP properties].

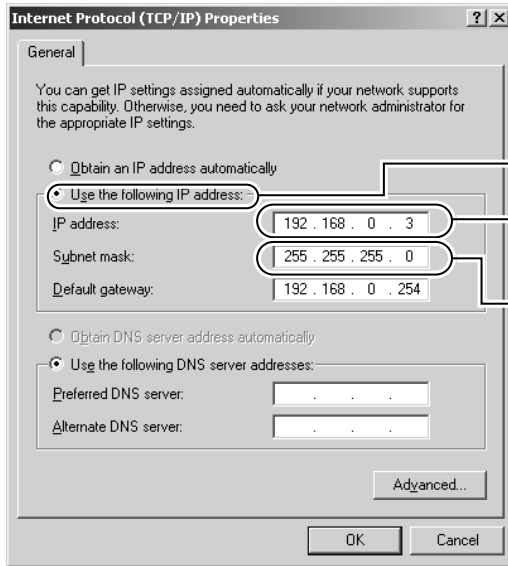

- ① Select [Use the following IP Address].
- ② Set the IP address to “192.168.0.3.”
- ③ Set [Subnet mask] to an appropriate value according to the operating environment. Ask the network administrator if necessary.

5. Click .

Preparations (Step 2 Setting the Network)

2-3 Setting the IP Address for VN-C10 with V.Networks Setup Tool

Set the IP address for VN-C10 by using the installed [V.Networks Setup Tool].
(With this [V.Networks Setup tool] only VN-C10, not other models, can be connected.)

Caution

- After the power for VN-C10 is turned on, there will be about 20 seconds until VN-C10 becomes ready to be connected with the PC. This is not a defect.
- At the factory, DHCP is set enabled for VN-C10.
- About the DHCP function
JVC does not recommend operating VN-C10 with this function enabled because a different IP address may be assigned upon the renewal of the leasing contract. The DHCP function of VN-C10 is designed for simplifying the installation and setting procedures.

Note

For connecting VN-C10 with the factory settings, either one of the environments described below is required.

- Environment where no DHCP server exists.
- Environment where a DHCP server exists, which clearly defines the allotted IP address and MAC address.

1. Select [Start], [Programs], [V.NETWORKS] and then  [vn-c10u Setup Tool] to start up [V.Networks Setup Tool].

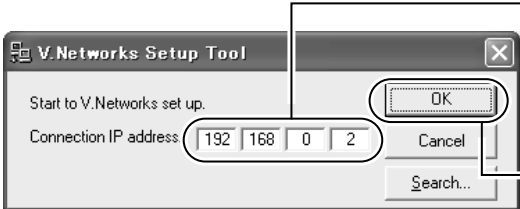

① Enter the IP address of the camera to be connected to [Connection IP Address]. The IP address is set to **192.168.0.2** at the factory.

② Click .

Note

Click [Search] to see the IP address of the connected camera.

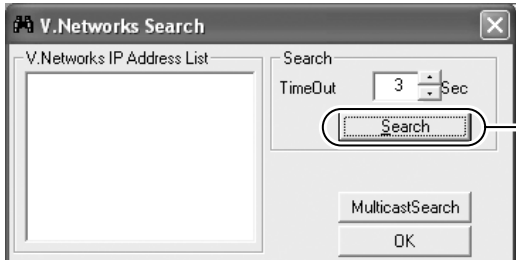

The [V.Networks Search] screen is displayed.

To start search, click [Search]. [V.Networks IP Address List] is displayed.

- [TimeOut] is for setting the time for searching (0 to 30 seconds).
If no IP address is displayed by searching, change the value to a longer one and then search again.
- If [V.Networks] on LAN has a different subnet from that of the PC, connection cannot be established even if the IP address of the camera can be searched and found. Reconnect the camera after changing the IP address of the PC accordingly.

2-3 Setting the IP Address for VN-C10 with V.Networks Setup Tool (continued)

2. Confirm the settings.

① Select whether to use DHCP.

Note

- With DHCP selected, the IP address of the DHCP server etc. can be checked.

② Change the IP address to the one allotted, or approved, by the network administrator.

③ Set the subnet mask to an appropriate value according to the operating environment. Ask the network administrator if necessary.

④ Click .

For other settings, next page

3. Click .



Click to update the values.

Note

A new IP address becomes effective when VN-C10 is automatically reset.

4. Start up [V.Networks Controller]. (Page 42)

Note

In a system where more than one VN-C10 are used, turn on the power for a VN-C10 first and proceed the setting to 2-4 Other Settings with V.Networks Setup Tool. Only then turn on the power for a second one and go on to 2-4. Repeat the procedure for the other cameras.

Preparations (Step 2 Setting the Network)

2-4 Other Settings with V.Networks Setup Tool

Set passwords, alarm, motion detection etc. by using the installed [V.Networks Setup Tool].

1. Select [Start], [Programs], [V.NETWORKS] and then  [vn-c10u Setup Tool] to start up [V.Networks Setup Tool].

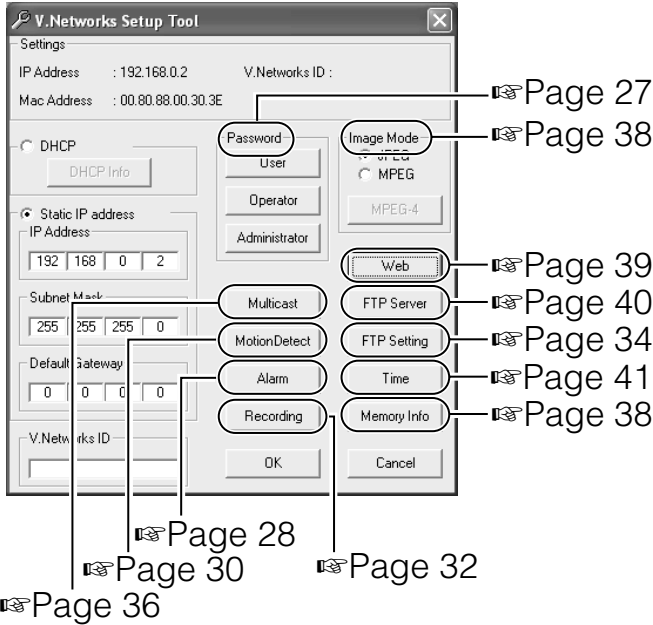

The screenshot shows the V.Networks Setup Tool window with the following settings and callouts:

- Settings: IP Address : 192.168.0.2, V.Networks ID : (callout to Page 27), Mac Address : 00.80.88.00.30.3E
- DHCP: DHCP Info (callout to Page 27)
- Static IP address: IP Address (192 | 168 | 0 | 2), Subnet Mask (255 | 255 | 255 | 0), Default Gateway (0 | 0 | 0 | 0), V.Networks ID (callout to Page 28)
- User: Password (callout to Page 27), User (callout to Page 30), Operator (callout to Page 30), Administrator (callout to Page 30)
- Image Mode: Image Mode (callout to Page 38), MPEG (callout to Page 38), MPEG-4 (callout to Page 38)
- Web: Web (callout to Page 39)
- FTP: FTP Server (callout to Page 40), FTP Setting (callout to Page 34)
- Alarm: Alarm (callout to Page 41), Recording (callout to Page 32)
- Memory: Memory Info (callout to Page 38)
- Buttons: OK, Cancel

Page 27

Page 38

Page 39

Page 40

Page 34

Page 41

Page 38

Page 28

Page 30

Page 32

Page 36

2. Refer to the relevant pages (☞) for these settings shown above.

2-4 Other Settings with V.Networks Setup Tool [1. Password Setting]

VN-C10 is equipped with an access protection (security) function that, by setting passwords, regulates users of the connected PC.

Setting and cancellation of passwords can be performed with [V.Networks Setup Tool].

According to access right (authorization) levels, up to 3 passwords (user, operator and administrator) can be set.

Access Right Level	Allowed Actions
User	Only viewing moving images
Operator	All operations with [V.Networks Controller]
Administrator	All of the above and all settings with [V.Networks Setup Tool]

Note

Do not forget the passwords as they cannot be changed unless the current, and correct ones are entered.

1. Start up [V.Networks Setup Tool] and select [User], [Operator] or [Administrator].

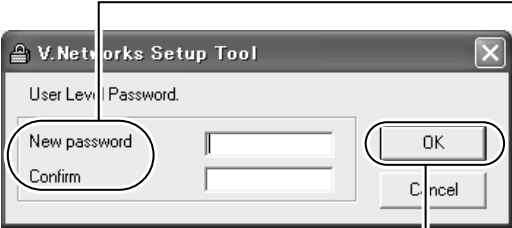

① Enter a password to set password protection or change the password. Entered characters are displayed as asterisks (*).

- Enter the same password for both boxes.
- A password must be alphanumeric and can be up to 8 characters.

Note

To cancel an existing password, leave the password entry box blank and click .

② Click .

2. The following screen is displayed for confirmation.



Click .

Note

- For a password-protected VN-C10, the password request screen appears.
- VN-C10 cannot be set up unless the correct administrator password is entered.
- The security level is highest for the administrator and lowest for the user. If password is set only for lower security level(s), password protection is not effective.

Preparations (Step 2 Setting the Network)

2-4 Other Settings with V.Networks Setup Tool [2. Alarm Setting]

This section describes alarm setting.

Alarm input is activated in the following cases.

- Input signals are received from an input terminal located on the rear panel of the camera, [ALARM INPUT 1] or [ALARM INPUT 2]. (☞ Page 16)
- Motion has been detected. (☞ Page 30)

Operation when alarm input is activated.

- Output signals are sent from the output terminal located on the rear panel of the camera, [ALARM OUTPUT]. (☞ Page 17)
- Alarm information is reported to [V.Networks Controller.] (☞ Page 29)
- Alarm Images are recorded. (☞ Page 32)

1. Start up [V.Networks Setup Tool] and select [Alarm].

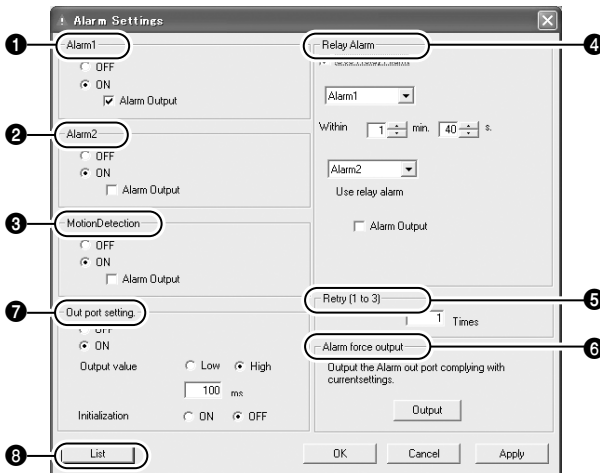

2. When the setting is complete, select [Apply] and then .

2-4 Other Settings with V.Networks Setup Tool [2. Alarm Setting] (continued)

1 Alarm 1

Select [ON] to convert signals input to the [ALARM INPUT 1] terminal to [Alarm 1] signals.

If [Alarm Output] is selected, alarm signals are sent to the [ALARM OUTPUT] terminal according to the output port setting.

2 Alarm 2

Select [ON] to convert signals input to the [ALARM INPUT 2] terminal to [Alarm 2] signals.

If [Alarm Output] is selected, alarm signals are sent to the [ALARM OUTPUT] terminal according to the output port setting.

3 Motion Detection

Select [ON] for motion within the set area to be recognized as a cause for an alarm.

If [Alarm Output] is selected, alarm signals are sent to the [ALARM OUTPUT] terminal according to the output port setting.

4 Relay Alarm

Select here to enable the alarm function, which is activated when two alarms are successively received within a certain period of time.

The sequence and interval of alarm input can be set.

If [Alarm Output] is selected, alarm signals are sent to the [ALARM OUTPUT] terminal according to the output port setting.

Note

- A second alarm input enables this relay alarm function, and alarm will not be activated for this second input.
- Unless the alarm output is enabled, this function is not activated even if [Alarm Output] of the [Alarm Settings] screen is selected.

5 Retry [1 to 3]

This function sets how many times an alarm alert to [V.Networks Controller] is repeated (1 to 3).

Note

Depending on the LAN environment, alarm alert might fail. If it fails, set the value to "3". In such a case, alarm by [V.Networks Controller] itself is set off only once.

6 Alarm force output

If [Output] is pressed, alarm signals are sent to the [ALARM OUTPUT] terminal. This forced output is used for checking the alarm function.

7 Out port setting

Enable this function to output alarm signals to the [ALARM OUTPUT] terminal.

Using output values, set the polarity, high or low, and output time (1 to 5000 ms) according to the equipment connected.

If initialization is set to start, the set alarm signal is output once when the power is turned on.

8 List

Press here to show the IP addresses of the PCs to which alarm input is reported. To delete an IP address, select the address and press [Delete].

Note

- If more than 10 destinations are set, this function is not activated.

Preparations (Step 2 Setting the Network)

2-4 Other Settings with V.Networks Setup Tool [3. Motion Detection Setting]

This section describes the setting of the motion detection function which enables VN-C10 to trigger an alarm when motion is detected in a specified area. Motion is monitored while being compared to the reference image. The area within which the function is effective can be set in the following procedure.

(This function cannot be set for MPEG4.)

1. Start up [V.Networks Setup Tool]. Select [Alarm] and then enable [Motion Detection Alarm].
(☞ Page 28 [Alarm Setting])

2. Select [Motion Detect] of [V.Networks Setup Tool].

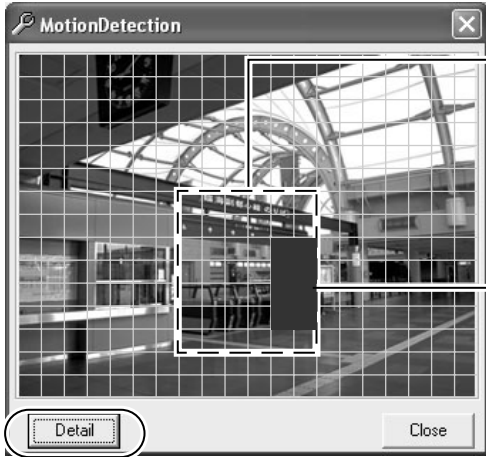

① Select the desired monitoring area by clicking and holding down the left button of the mouse and dragging it. The selected area is displayed in yellow. Click the right button of the mouse and, while holding it down, drag the mouse to cancel a monitoring area.

The area in which motion has been detected is displayed in red.

② The [Detail] button is used for more detailed settings.

Note

- A selected area is only for reference. To ensure accuracy, perform operation check.
- One screen is divided in 300 (20x15) blocks. Adjust magnification of the lens so that the monitoring area (object) covers more than one block.

Caution

The motion detection function is not designed to prevent burglary or fire. It may not function properly depending on the condition of the object or settings described in this document. In no case, shall JVC be liable for any accidents and/or damage caused.

3. Press [Detail] to display [Motion Detection Setting].

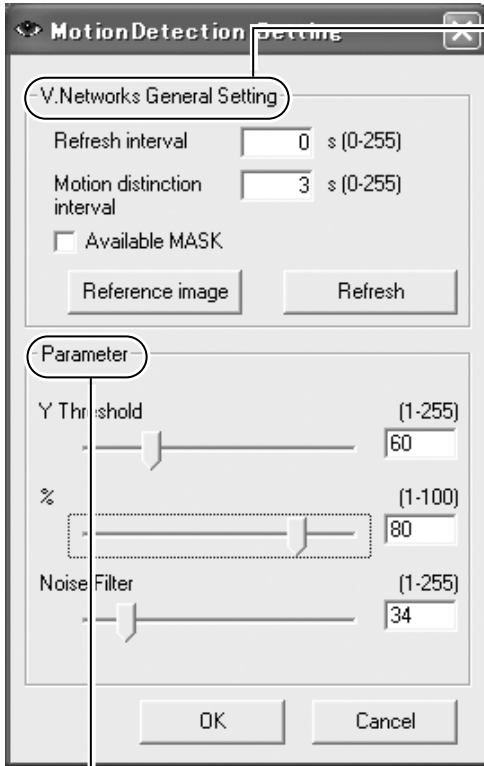

V.Networks General Setting

Refresh Interval

The reference image on which motion detection is based is refreshed at a regular interval. In a condition where the reference image changes, like outdoors, set a low value.

Note

With the interval set to "0 second," the reference image is automatically refreshed if a motion is not detected for 10 seconds.

Motion Distinction Interval

This is for setting the minimum duration of time for which the object being monitored must move to be recognized as "motion." If the object is slow moving, the time should be longer to avoid detection errors.

Available MASK

Areas outside the one already set for motion detection (displayed in yellow) can also be selected.

Reference Image

For checking the reference image. The screen below is displayed.

Refresh

Press this button to refresh the reference image.

Parameters

Y Threshold

A smaller value allows motion detection even if the difference of brightness with the reference image is insignificant.

%

Set to a smaller value if the moving object is not large enough and cannot be detected.

Noise Filter

Set to a larger value to reduce noise in the whole image.



Updates the reference image.

If this is selected, the reference image is automatically refreshed at a designated interval.

Preparations (Step 2 Setting the Network)

2-4 Other Settings with V.Networks Setup Tool [4. Recording Setting]

This function records the image to the memory of VN-C10 when an alarm is activated. (This cannot be set for MPEG4.)

- When an alarm is activated, image recording can be carried out in one of the following two ways. One way, local recording, saves images to the VN-C10 memory, and the other records images with [V.Networks Controller] and saves them to the PC hard disc drive, etc. (Page 51)

1. Start up [V.Networks Setup Tool] and select [Recording].

To make new values effective, press [Apply] and then .

Trigger Recording

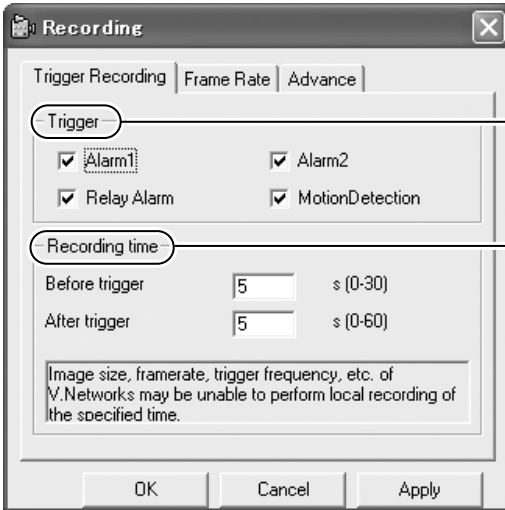

① For selecting the record starting trigger, the alarm input signal to start local recording.

② For setting the recording time. Up to 60 seconds can be set both before and after an alarm input.

Caution

- If the value for before a trigger is set to "0," set a different value for after the trigger. Both values cannot be set to "0" at the same time.
- Because of the memory capacity of VN-C10, the setting times before and after a trigger and the actual maximum recording time are not the same.

Example:

- If 160x120 (30 fps)/320x240 (15 fps)/640x480 (5 fps) with a compression rate of 2, the actual recording time is 5 to 0 and 30 to 35 seconds, before and after a trigger respectively.
- For the maximum recording (30 before and 60 seconds after a trigger), perform the setting as follows:
Image size : 160x120
Frame rate : 30 fps
Compression rate : 7

2. Frame Rate



③ For setting the frame rate for local recording, select [Change the Recording FrameRate during trigger recording] and set the frame rate (30, 15, 10, 8, 7, 6, 5, 4, 3, 2 or 1). The default value is 30 fps.

3. Others



- ④ Set the recording action when the memory capacity for recording has become full. One of the following two can be selected. (The internal memory capacity is 8 MB.)
- Stop recording until a free memory space for recording is created.
 - Delete files older than the designated number of days. (If the number of days is set to “0,” the files are deleted, starting with the oldest one.)

Note

Recording time

- While maximum recording time varies depending on the recording frame rate and image size, recording may not be possible for a desired length of time because of other factors such as the compression rate and the object quality.

Recording files

- A trigger-recording file is created each time a trigger occurs. Even if triggering keeps occurring and recording continues, only one file will be created for each trigger.

Caution

Saving images of local recording to the PC

As local recording images are saved to the VN-C10 volatile memory, the images are deleted if the power is turned off.

Rec files that were locally recorded can also be automatically uploaded to an FTP server. (Page 34 “Rec File FTP”)

With recording by [V.Networks Controller], with which images are saved to the PC hard disk drive, etc., saved files can be retained even if the power is turned off.

For saving local recording images to the PC, follow the procedure below.

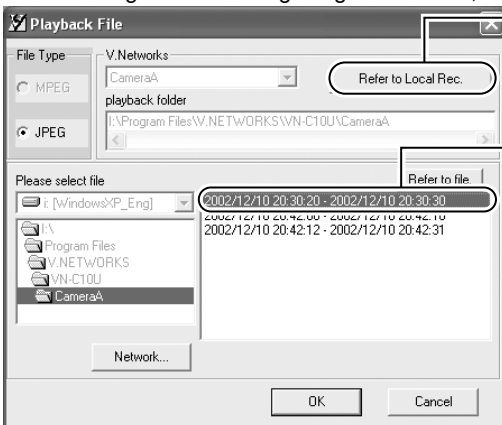

- ① Select [Refer to Local Rec].
- ② Select the file to save it to the PC.
- ③ Right-click the file to select [Download to PC].

By selecting desired items in [Trigger] and also performing necessary settings for [Message], etc. in [Alarm Setting], you can be certain whether or not local recording has already started. (Page 51)

Preparations (Step 2 Setting the Network)

2-4 Other Settings with V.Networks Setup Tool [5. FTP Client Setting]

VN-C10 is equipped with an FTP client function which regularly uploads still images to an existing FTP server, thus enabling simultaneous image monitoring at many places and by many people.

(This function cannot be set for MPEG4.)

1. Start up [V.Networks Setup Tool] and select [FTP Setting]. The [FTP Setting] screen is displayed.

The screenshot shows the 'FTP Setting' dialog box with the following fields and callouts:

- 1: FTP (radio buttons for Available and Not Available)
- 2: Rec File FTP (radio buttons for Available and Not Available)
- 3: Username (text field with 'anonymous' and '(1-16 characters)')
- 4: Password (text field with '(0-32 characters)')
- 5: FTP Server IP Address (text field with '0 0 0 0')
- 6: FTP Port (text field with '21' and '(Normally port 21)')
- 7: FTP Folder (text field with '(0-64 characters)')
- 8: Upload Interval (text field with '60 s' and '(0-84600)', and a checkbox for 'disconnect everytime')
- 9: Error recovery (radio buttons for 'Retry forever' and '10 min. Retry. (1-600)', and a checkbox for 'Stop Uploading')
- 10: Filename (radio buttons for 'vnetworks .jpg' and 'Timestamp (ex.2002-01-23-01-23-45-678.jpg)')

Buttons at the bottom: OK, Cancel, Apply.

1 FTP

To use the FTP function, select [Available].

2 Rec File FTP

Select [Available] if locally recorded *.rec files are to be uploaded to an FTP server automatically.

Note

- Uploading automatically starts when a rec file was created.
- Delete Rec file according to the [Lower memory size] setting of the Record setting screen.
- When the built-in memory size of the main unit is not enough to create a Rec file, [Rec file FTP] can not be set. When [Rec file FTP] is available, it is recommended that the [Lower memory size] be set to [remove old files 0 days].
- While uploading a Rec file, uploading of still images temporarily stops.

3 User Name

Enter the user name to use for verification with the FTP server. It can be “anonymous.”

4 Password

Enter the password to use for verification with the FTP server. The password is displayed as asterisks (*).

5 FTP Server IP Address

Enter the IP address of the upload destination FTP server.

6 FTP Port

Enter the FTP port number of the upload destination. This is normally set to “21.”

7 FTP Folder

Enter the folder name on the upload destination FTP server. If this box is left blank, images are uploaded to the default folder.

8 Upload Interval

Specify the upload interval at which images are uploaded to the FTP server.

(0 to 84600 seconds)

If [Disconnect every time] is selected, connection with the FTP server is cut after an image was uploaded.

9 Error Recovery

(Connection error)

Specify a recovery action when an error occurred for TCP connection or FTP verification of VN-C10.

Retry forever : Recovery attempt is repeated until the power for VN-C10 is turned off.

*min. Retry : Recovery attempt is repeated for a specified period (*1 to 600 minutes).

(Transfer error)

Select a recovery action when a transfer error occurred in uploading an image.

FTP Disabled: The FTP function is automatically disabled.

Note

To enable the function again, select [Available] for [FTP].

10 Filename

*.jpg : If this file type is selected, uploading is performed with the entered file name.

Note

Only one image file is stored in the FTP server as files are overwritten with the latest one.

Time stamp : Files are uploaded with the time of the built-in clock as their file names.

Note

- Set the correct time in the [Time Setting] screen.
- All uploaded image files are stored in the FTP server.

Preparations (Step 2 Setting the Network)

2-4 Other Settings with V.Networks Setup Tool [6. Multicast]

Selecting [Multicast Mode] allows VN-C10 to send the same image data to multiple recipients on the network at one time without lowering the frame rate.

- In a narrowband environment, for example, of dial-up connection, select [Unicast Mode].
- Multicast cannot be set for MPEG4.

1. Start up [V.Networks Setup Tool] and select [Multicast]. The [Multicast Setting] screen is displayed.

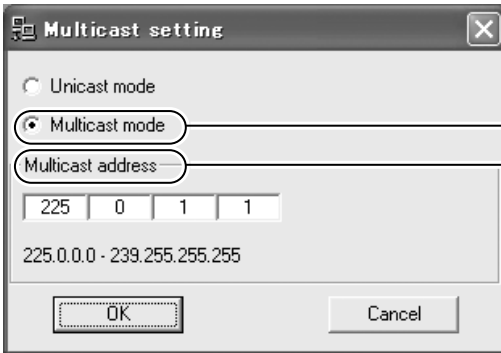

① Select [Multicast Mode].

② Enter a multicast address to [Multicast address].

Multicast

- A multicast address can be set from 225.0.0.0 through 239.255.255.255. Do not set the same multicast address for different devices on the same system.
- To view VN-C10 images in the multicast mode through a router, an operating environment or a router setting is required as follows:
 - ① The router supports IGMP Ver. 2 and is synchronized with the starting and stopping of multicast transmission. And the route setting can be dynamically changed.
 - ② If the router does not support IGMP Ver. 2, a static route for multicast must be set to the router.

2-4 Other Settings with V.Networks Setup Tool [6. Multicast] (continued)

VN-C10 multicast addresses on the network can be searched.

1. Start up [V.Networks Setup Tool]. Select [Search].



2. The [V.Networks Search] screen is displayed.

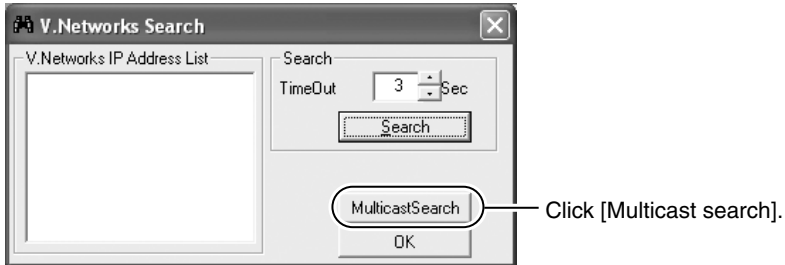

3. The [Multi Address Search] screen is displayed.

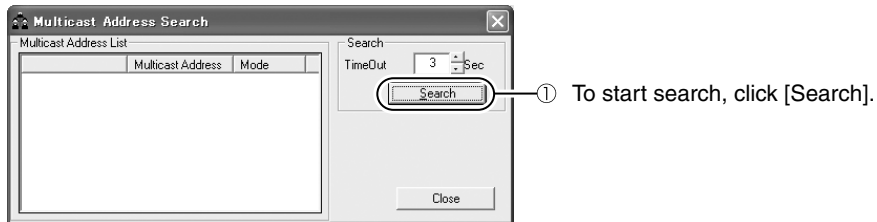

4. The search result is displayed.

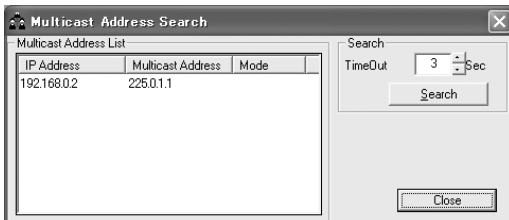

Preparations (Step 2 Setting the Network)

2-4 Other Settings with V.Networks Setup Tool [7. Compression Format]

Either JPEG or MPEG4 can be selected as the image compression format.

1. Start up [V.Networks Setup Tool] and for the compression format, select JPEG or MPEG4. For MPEG4, select [MPEG-4].

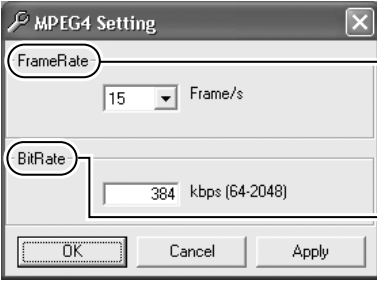

① Set the frame rate for MPEG4 (30, 15 or 7.5). For smoother display of images, set a larger value.

② Set the bit rate for MPEG4 (64 to 2048). For a better image quality, set a larger value.

Caution

- With MPEG4, up to 4 clients can be connected at one time. If 5 or more clients are connected, the message “The VN-C10U has not start the Streaming Service.” appears.
- In the MPEG4 mode with the frame rate set to 30 fps, image noise may appear momentarily depending on the condition of the object. This is not a defect.

2-4 Other Settings with V.Networks Setup Tool [8. Memory Capacity]

Memory capacity can be checked.

1. Start up [V.Networks Setup Tool] and for the compression format, select [JPEG] or [MPEG4].

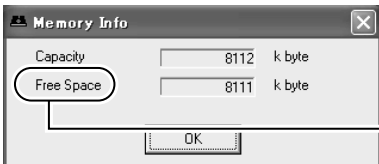

① Check the free memory space. The memory capacity of VN-C10 is 8000 kB.

2-4 Other Settings with V.Networks Setup Tool [9. Web]

An HTML file can be set as the default page of the web browser.

1. Start up [V.Networks Setup Tool] and select [Web].

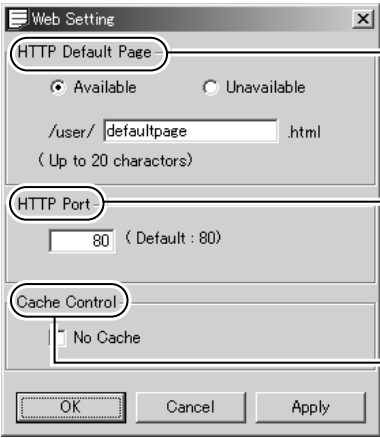

① Select whether to enable the setting of the HTTP default page. If [Available] is selected, specify an html file for the default page.

② Set the port number.

③ There are a few types of proxy server that caches CGI and the above setting cannot be properly done. In such a case, select [No Cache].

Caution

- It is possible to enhance the level of security by changing the default port number (80) of VN-C10 HTTP server (1 through 65535 excluding 21 and 554). With this number changed, it can be accessed with a Web browser by entering “http://192.168.0.2:12345” or “http://192.168.0.2:12345/index-e.html” (in the case of the port number, 12345). If you have forgotten the port number, refer to [Setup Tool].
- The default page refers to the page displayed when the IP address is specified (for example, “http://192.168.0.2/”) in a Web browser. Even with this function enabled, if the specified file does not exist, the message, “404: Not Found” will be displayed when “http://192.168.0.2/” is entered.

Preparations (Step 2 Setting the Network)

2-4 Other Settings with V.Networks Setup Tool [10. FTP Server]

Using FTP client software, HTML pages, GIF and JPEG images can be uploaded.

1. Start up [V.Networks Setup Tool] and select [FTP Server].

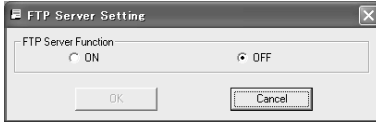

Select whether to enable or disable the FTP server function.

Note

- The FTP server name is fixed to [Administrator] and also use the password for the administrator.
- For the FTP user area, approximately 300 kB are allotted.
- All uploaded folders are stored directly under the [user] folder. It can be accessed as in “http://192.168.0.2/user/aaa.html” with a Web browser. (“192.168.0.2” denotes the VN-C10 IP address when “aaa.html” is referred to.)
- Folders cannot be created in the VN-C10 FTP server. Only uploading, deleting and renaming of files are possible.

2-4 Other Settings with V.Networks Setup Tool [11. Time Setting]

This section describes how to set the standard time for VN-C10. NTP can be used for this function.

1. Start up [V.Networks Setup Tool] and select [Time].

There are two ways to set the time, with or without NTP.

NTP is not used.

- ① Set the date and time.
- ② The time by the PC clock can be checked.

NTP is used.

- ① Enter the IP address of the NTP server.
- ② Set the time zone.
- ③ Set the interval at which the current time is obtained from the NTP server.

Note

- An NTP server is required for the NTP setting.
- If the time setting is changed while local recording is in progress, the local recording time may not be properly counted. Thus, recording for the specified seconds may not be obtained.
- We recommend using an FTP server. Without it, the time returns to the initial value, January 1, 1900, when the power is turned off. In a situation wherein an FTP server cannot be used, set the time appropriately when the power is turned on again.
- With Windows XP Home Edition and Windows XP Professional, NTP sever functions become enabled when they are installed in the standard procedure.
- For Windows 2000, follow the procedure below to enable NTP server functions.

1. Set the value for the following registry to "1." (The default value is "0.")

HKEY_LOCAL_MACHINE\SYSTEM\CurrentControlSet\Services\W32Time\Parameters\LocalNTP

Registry editing is a highly risky operation.

Safety measures should be taken beforehand, e.g. creating registry backups. JVC shall not be held liable for any loss caused by registry editing.

2. Restart the Windows Time Service.

This can be done by opening [Administrative Tools] in [Control Panel] and selecting [Services], [Windows Time] and [Windows Time Properties].

Preparations (Step 2 Setting the Network)

2-5 Registering the Connected Camera with V.Networks Controller

The connected camera can be registered with the installed [V.Networks Controller].

1. Select [Start], [Programs], [V.NETWORKS] and then  [V.Networks Controller] to start up [V.Networks Controller].

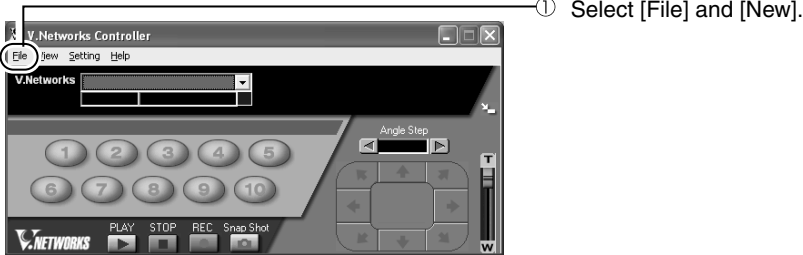

2. [New] is displayed.

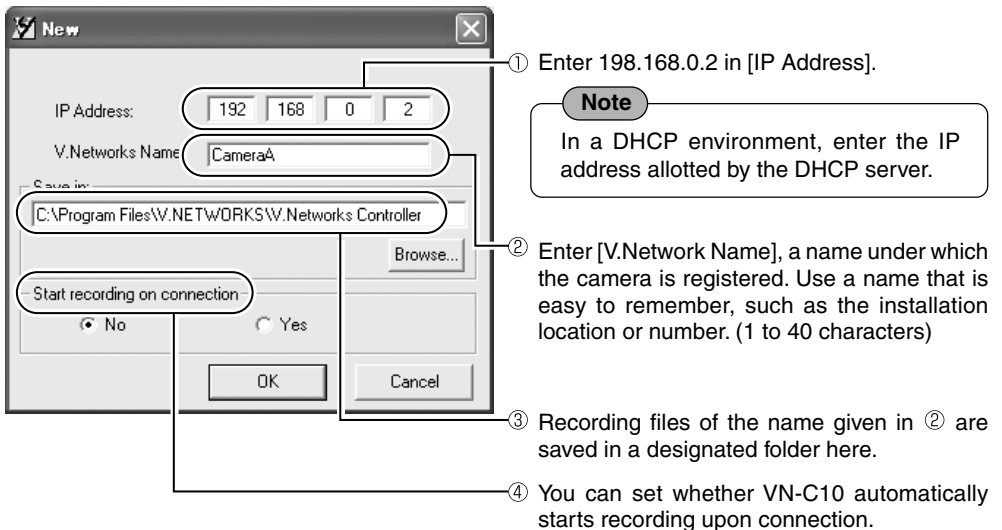

Note

For connecting VN-C10 with the factory settings, either one of the environments described below is required.

- Environment where no DHCP server exists.
- Environment where a DHCP server, which clearly defines the IP address and MAC address allotted to VN-C10, exists.

Preparations (Step 3 Adjusting the Camera)

3-1 Back-focus Adjustment

At the factory, back-focus is set at the point for the widest range of use for CS-mount. However, it is necessary to readjust back focus if a zoom or C-mount lens is used or if focus cannot be attained using the focus ring of the lens. To adjust, follow the procedures described below.

In order to adjust back-focus appropriately, use the iris adjustment function and an ND filter to release the lens iris before proceeding with the adjustment. (An ND filter acts to reduce the overall amount of light entering the lens equally over all wavelengths.)

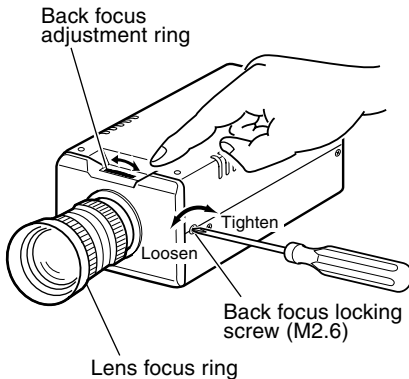

<For a fixed-focus lens>

If focus cannot be attained using the focus ring of the lens, adjust the back-focus as follows.

1. Loosen the back-focus lock screw by turning it counterclockwise with a Phillips screwdriver.
2. Aim the camera at the object or a spot of detail somewhere away from the object while checking the image on the PC screen.
3. Turn the focus ring to ∞ .
4. Turn the back-focus adjustment ring to optimize the focus.
5. Tighten the back-focus lock screw securely by turning it clockwise.

<For a zoom lens>

If the image gets out of focus when zoomed in/out, adjust the camera as follows:

1. Loosen the back-focus locking screw by turning it counterclockwise with a Phillips screwdriver.
2. Aim the camera at the object or a spot of detail somewhere away from the object while checking the image on the PC screen.
3. Zoom in the lens and adjust the focus by turning the focus ring.
4. Zoom out the lens and adjust the focus by turning the focus ring.
5. Repeat steps 3 and 4 a few times.
6. Tighten the back-focus locking screw securely by turning it clockwise.

Operations (Step 4 Setting with V.Networks Controller)

4-1 Starting Up V.Networks Controller

With the installed Controller, camera images can be monitored. The settings for recording, replay and frame rate etc. can also be performed.

1. Select [Start], [Programs], [V.NETWORKS] and then  [V.Networks Controller] to start up [V.Networks Controller].



- ① In the pull down menu, select the camera to connect.

Caution

After the power for VN-C10 is turned on, there will be about 20 seconds until VN-C10 becomes ready to be connected with the PC. This is not a defect.

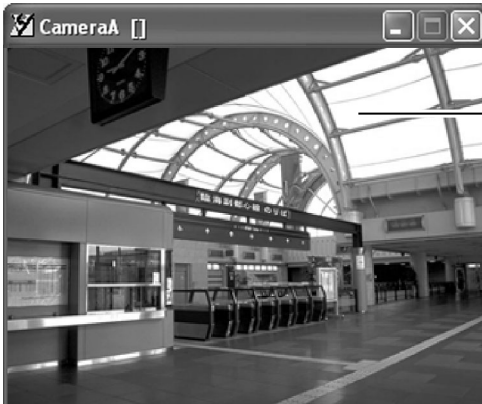

- ② Live images from the camera are displayed.

Note

- If a password has been set, enter the correct password.
- This [Controller] can be connected to VN-C1, VN-C2, VN-C3, VN-C30 (only for JPEG), VN-A1 and VN-C10.
- In the MPEG4 mode, up to 4 clients can be connected at one time. If 5 or more clients are connected, the message "The VN-C10U has not start the Streaming Service." appears.

4-2 Function Settings with V.Networks Controller

With [V.Networks Controller], settings for image size, alarm etc. can be performed.



1 File

- New : Creates a new file if the camera is connected for the first time.
- Delete : Deletes a file.
- Motion Detect Standby : For selecting the camera for which motion detection is enabled.
- Exit : Exits "Controller."

2 View

- Image Size : Sets the image display size.
 - JPEG : 640x480
320x240
160x120
 - MPEG4 : 320x240
160x120
- Upside Down : Displays the image inversely. This function is used in the case that the camera is inversely installed. (Not available for MPEG4)

3 Setting

- Quality : Sets the compression rate and image quality.
- Framerate : Sets the number of frames transmitted per second.
- Alarm Reg : If this is selected , alarm operation will be enabled.
- Alarm : Alarm actions for each alarm can be set individually.
- Time Stamp : Sets display of the date and time of file saving.
- Property : Changes information on cameras not currently connected.

4 Help

- About : For checking the version of [V.Networks Controller].

Operations (Step 4 Setting with V.Networks Controller)

4-3 Motion Detection Standby

With [V.Networks Controller] running, automatic connection will be activated upon reception of motion detection alert from VN-C10.

1. Select [File] and then [Motion Detect Standby].



2. Select the camera.

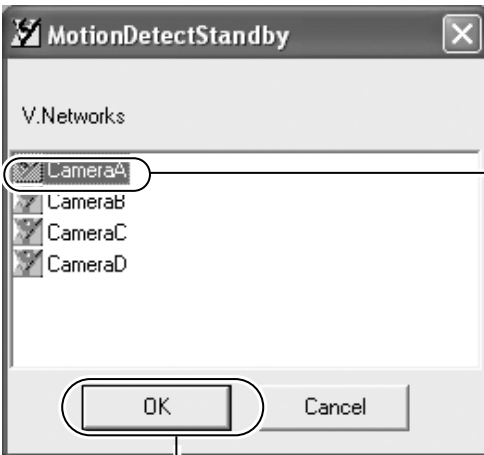

① Select the camera for which you wish to enable the motion detection function.

② Click .

3. Click .

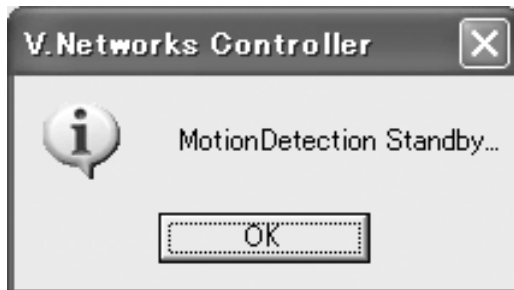

4-4 Image Size and Inversion

With [V.Networks Controller], it is possible to set the size of the moving image window and invert the image.

1. Select [View].



2. Select an image size and whether or not to invert the image.

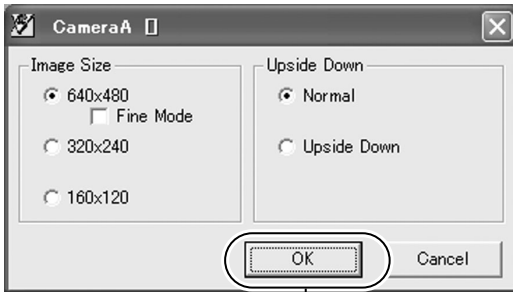

Note

- With MPEG4, the following settings are not available.
 - 640x480
 - Upside Down
- In the Fine mode, image details can be checked.
Not suitable when a moving object is to be recorded. (only for VN-C10 firmware version 1.4 and subsequently)
- 640 x 480 size is only use in fine mode.

Click .

Note

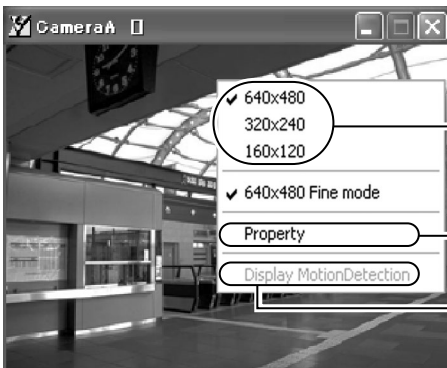

Right-click on the moving image window to change the settings. (This setting is not available for MPEG4.)
Set the image size.

Displays the MAC address, IP address, model, firmware version.

If this is selected, the blocks for motion detection are displayed. The blocks where motion is detected will be displayed in red.

Operations (Step 4 Setting with V.Networks Controller)

4-5 Setting the Image Quality

With [V.Networks Controller], settings for image quality such as the image compression rate, white balance, etc., can be done.

1. Select [Setting] and [Quality].



2. Change the set values. (For functional description, see next page)

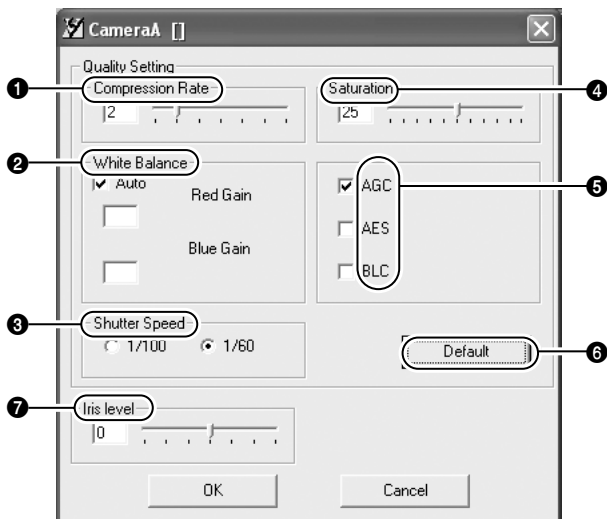

3. Click .

4-5 Setting the Image Quality (continued)

1 Compression Rate

Sets the image compression rate. A lower compression rate means a higher image quality. However, with a reduced compression rate, data volume also increases.

This setting is not available for MPEG4.

Value range: 1 to 7 (Set to "2" at the factory)

2 White Balance

Auto : Automatically adjusts the white balance, the standard for color saturation. Factory set.

R gain : To manually adjust the white balance toward more red intensity.
Value range: 0 to 100

B gain : To manually adjust the white balance toward more blue intensity.
Value range: 0 to 100

3 Shutter Speed

1/60 : Normal speed. Factory set.

1/100 : This reduces image flickers due to fluorescent lighting in areas where the commercial power frequency is 50 Hz.

4 Saturation

Adjusts color saturation. A smaller value makes colors less dense. Set to "25" at the factory

5 AGC, AES, BLC

AGC : Automatically adjusts the gain in accordance with the brightness. Factory Set.

AES : Automatically adjusts the shutter speed in accordance with the brightness. Only for a manual iris lens.

BLC : Back light compensation. When there is a bright light source in the background of the object, VN-C10 adjusts the weighted zone.

Photo-metering Area

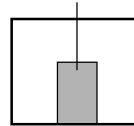

Note

- AES cannot be turned on when AGC is set to [OFF].
- AES cannot be turned on if the shutter speed is set to [1/100].
- BLC cannot be turned on when AGC is set to [OFF].
- Do not use AES with a DC IRIS lens. It may cause flickering.

6 Default

Returns all values, except that for iris level, for image quality to those set at the factory.

7 Iris level

Brightness adjustment for a DC IRIS lens. A smaller value makes images darker, closing the iris.

Operations (Step 4 Setting with V.Networks Controller)

4-6 Frame Rate

With [V.Networks Controller], it is possible to set the frame rate, the number of image updates per second, for JPEG.

Frame rate setting with [V.Networks Controller] is possible only for JPEG.
Frame rate for MPEG4 can be set with [V.Networks Setup Tool]. (Page 38)

1. Select [Setting] and [Framerate].



2. Set the frame rate in the [Frame Rate] screen.

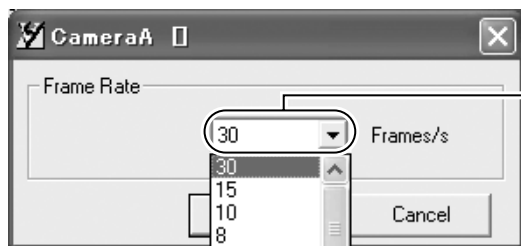

Sets the maximum number of images per minute that are sent from VN-C10. This value is set to “15” at the factory.

Note

The actual number of frames received and displayed per second is affected by factors such as the PC performance and the image compression rate as well as the LAN environment. In the case of a LAN environment where multiple operations are being performed at one time (particularly where the network traffic is always heavy), reduce the number of frames to be transmitted.

Caution

Frame rate for local recording cannot be set with [V.Networks Controller]. It is only possible with [V.Networks Setup Tool]. (Page 32)

4-7 Alarm Setting

With [V.Networks Controller], it is possible to set the action to be taken upon reception of an alarm signal.

1. Select [Setting] and [Alarm Setting].



2. Change the set values. (For functional description, see next page)

Settings are performed for [Motion Detection Alarm], [Alarm 1], [Alarm 2] and [Relay Alarm].

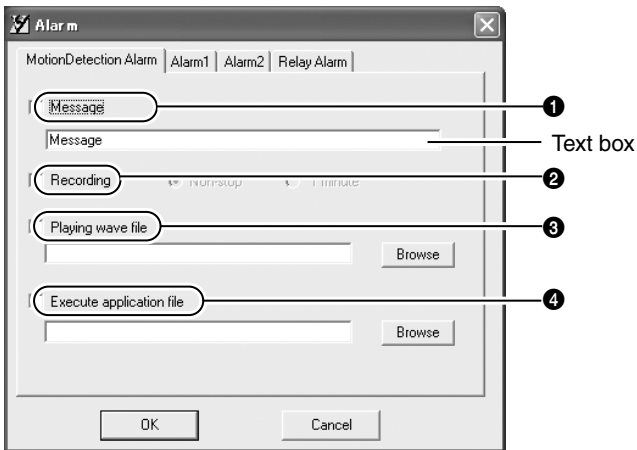

(With [Relay Alarm] selected, 1 and 2 cannot be set.)

3. When the settings are complete, click .

Operations (Step 4 Setting with V.Networks Controller)

4-7 Alarm Setting (continued)

① Message

When an alarm is received, the message entered into the text box is displayed. The maximum number of characters that can be entered is 100.

② Recording

When an alarm is received, recording starts.
Non-Stop : Recording continues until the Stop button is pressed.
Stop 1min : Recording stops after 1 minute.

Note

- The [Stop 1min] mode is for conserving the hard disk space.
- In this mode, recording stops after 1 minute even if recording has already started before the alarm input.

③ Playing wave file

When an alarm is received, a specified Wave file is replayed. Press the [Browse] button to specify a Wave file.

Note

If a large Wave file (.wav) is selected, the alarm operation may become slow depending on the PC performance.

④ Execute application file

When an alarm is received, a specified program is executed. Press the [Browse] button to specify a program.

Note

Alarm Operation

The following settings are required for the operation of the alarm that has been set.

1. [Alarm Reg] is enabled in the [Setting] menu of the [V.Networks Controller.] (☞ Page 45)
2. Each alarm setting in [Alarm Setting] of [V.Networks Setup Tool] is enabled. (☞ Page 28)

Relay Alarm

When the relay alarm function is enabled, subsequent alarms will not be activated.

4-8 Time Stamp

With [V.Networks Controller], the [Time Stamp] function can be set. This function displays the date and time on the camera images, and the date and time are recorded.

1. Select [Setting] and [Time Stamp].



2. Proceed with the setting.

① Select [Visible].

② Select the display style in [Style].
“YYYY,” “MM,” and “DD” represent “year,” “month” and “day” respectively.
“HH” represents “hour” while “MM,” “minute,” “SS,” “second” and “mm,” “millisecond.”

③ Click [Font...] to select the font.

④ Set the text color in [TextColor].

⑤ Set the background color in [BackColor].

⑥ Click .

Note

- With MPEG4, ③, ④ and ⑤ cannot be set.
- By left-clicking the mouse while holding down the [shift] key on the moving image or playback window screen, the time stamp will appear where the mouse was clicked.
- Time stamp in the MPEG4 mode is shown in the title bar of the image window.

Operations (Step 4 Setting with V.Networks Controller)

4-9 Changing the Registered Information

With [V.Networks Controller], registered information on camera connection etc. can be changed.

1. Select [Setting] and [Property].



2. Proceed with the setting.

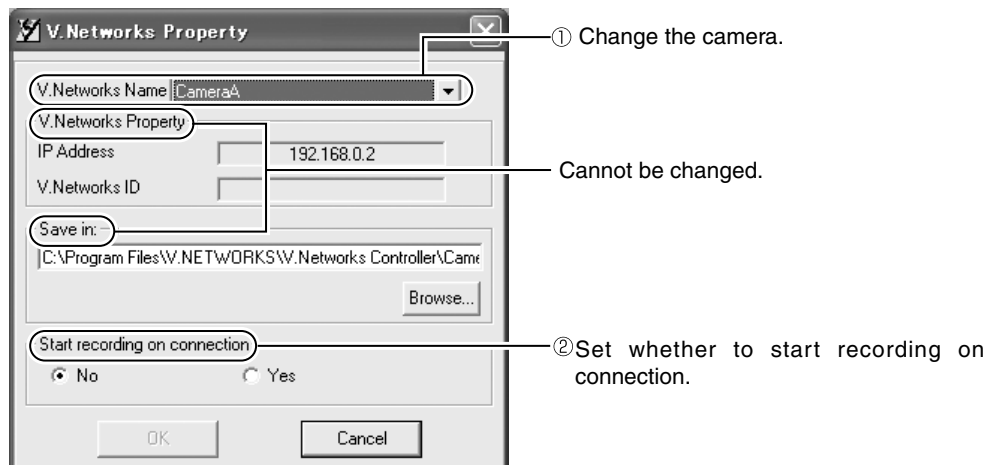

3. When complete, click .

Caution

Information cannot be changed for a connected camera.

Operations (Step 5 Operations with V.Networks Controller)

5-1 Operations with V.Networks Controller

[V.Networks Controller] can be used to select the camera, record and playback the camera images etc.

(The Controller screens are identical with those for other V.Networks models. Certain functions are not available for VN-C10.)

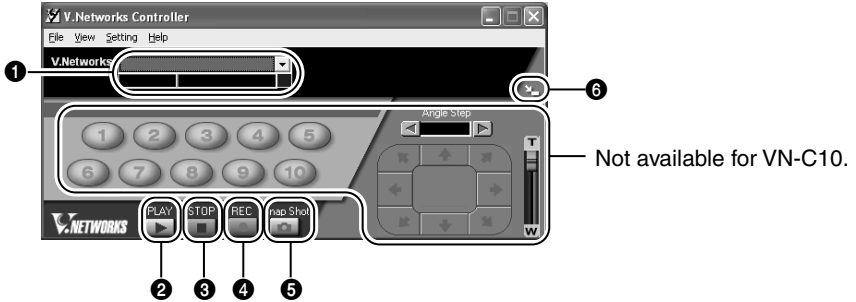

1 Camera

Displays the name of the connected camera. It is also possible to select the camera using the pull down menu.

2 PLAY

Select the file saved in 4 and replay. Select this button too for replaying a recorded file with an alarm activated.

3 STOP

Stops recording.

4 REC

When this is selected, recording starts. The recorded files are saved under the name shown in 1. During recording, the display [Recording in progress] appears in 1. The display [REC] will also appear on the displayed image.

5 SNAPSHOT

Saves only one frame of the image being displayed.

6 SIZE

Reduces the size of the [V.Networks Controller] screen. (See below.)

Reduced screen



Operations (Step 5 Operations with V.Networks Controller)

5-2 Record/Stop

[V.Networks Controller] can be used to save camera images to a file.

1. Click the [REC] button.

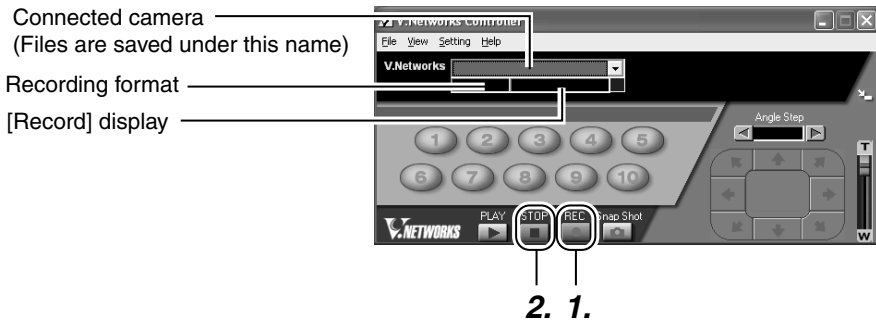

(Moving image window)



2. Click the [STOP] button.

Recording stops. The [Recording] and [REC] displays disappear.

When the [Snapshot] button is clicked, one single frame of the image being displayed is recorded.

(☞ Page 60)

Note

- Refrain from attempting continuous recording for an extended period of time. Files recorded over an extended time may not be replayed fully due to an insufficient memory space of the PC.
- Do not change the record file name.

5-3 Playback

For playback, select the file saved with the record function of [V.Network Controller]. The playback function cannot be effective while moving images are displayed.

1. Click the [PLAY] button.



[PLAY] button

2. Select the file you wish to replay from [Playback File] and click . To replay a local recording file, click [Refer to Local Rec.]. And select the file.

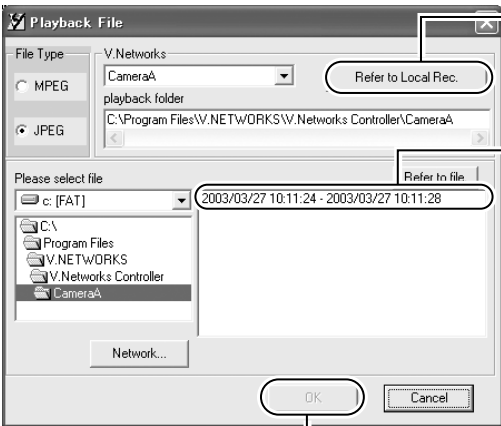

Press [Refer to Local Rec.] to select the file.

A file name is displayed as the time when recording started to the time when it ended.

Click .

Operations (Step 5 Operations with V.Networks Controller)

5-3 Playback (continued)

3. Click .



4. [Playback] is displayed.



Sliderbar

- Moves toward the right as the playback time progresses.
- Can be dragged with the mouse.

[Stop] button
[Pause] button
[Play] button

5-4 Other Instructions on Record and Playback

Record/Playback time

- Do not record or play a file that exceeds 2 GB with [V.Networks Controller]. With Windows applications, data in excess of 2 GB cannot be randomly accessed.

Approximate recording time for 2 GB JPEG data (at 5 frames per second)

Image size	Data size per image	Approximate recording time
160 x 120	Approx. 5 kB	20 hours
320 x 240	Approx. 15 kB	6 hours
640 x 480	Approx. 50 kB	2 hours

Approximate recording time for 2 GB MPEG4 data

Bit rate	Approximate recording time
64 kB/s	65 hours
384 kB/s	10 hours
2048 kB/s	2 hours

Operations (Step 5 Operations with V.Networks Controller)

5-5 Snapshot

With [V.Networks Controller], images being displayed or replayed can be saved as still image files.

1. Click the [SnapShot] button.



Note

Snapshots are saved as JPEG files in the JPEG mode and as BMP files in the MPEG mode.

[SnapShot] button

2. The [Snap] screen appears.



① Select [File] and [Save].

3. The [Save As] screen appears.

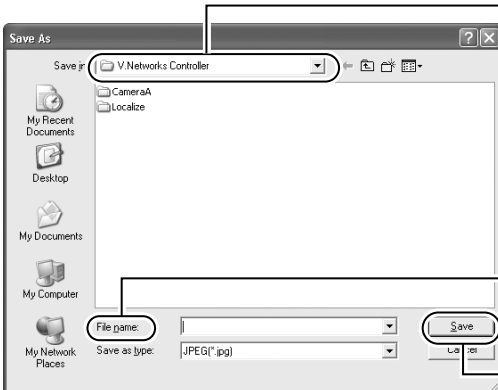

① Specify the folder into which the file is saved.

② Enter the file name.

③ Press [Save] to save a snapshot.

Note

Other viewer software

- Still-image files saved with VN-C10 can be viewed with general viewer software. However, images inverted by VN-C10 will not be displayed as such. Also, image color may also be different.

Operations (Step 6 Operations with a Web Browser)

It is possible to view still/moving images and perform various settings via not only the provided [Controller] software but via a Web browser as well.

However, note that MPEG4 files cannot be viewed with a browser. Also, the browser does not support the image inversion function.

6-1 Required Operating Environment

The following environment is required for viewing and operating VN-C10 with a Web browser. **It is necessary for the PC to satisfy the technical requirements described in this instruction manual (☞ Page 7).**

The PC must also satisfy the following Web browser conditions:

- A Web browser compatible with JavaScript and frame, that is, Netscape Ver. 4.x or Internet Explorer Vers. 4.x, 5.x and 6.x.
- For the recommended CPU performance and required memory capacity, refer to the Web browser in use.

For smooth display of large-screen moving images, specifications much better than those recommended are necessary.

Images from the camera will not be displayed properly in the 256-color mode.

- For Internet Explorer, an environment where Java can be properly run (Microsoft VM) is required.

LAN Environment

- VN-C10 can work as a web server that uses HTTP. Access linkage using a host name is possible if the environment supports DNS (Domain Name System).
- A direct connection of VN-C10 to a PC is possible using a cross-over cable. (Though rare, certain LAN boards do not allow the use of a cross-over cable. Be sure to check your LAN board.)

Note

Web page images

Web page images shown in this document refer to Web page data within VN-C10, including images captured by the VN-C10 camera and displayed by a Web browser.

Depending on the type and settings of the Web browser, the page format and character fonts of the displayed Web pages may vary. Should the page contents fail to be displayed in total, try resizing the window, etc.

The illustrations in this manual are obtained from Internet Explorer display screens.

For Internet Explorer

- After the password has been changed, the password authentication window may ask for the password twice. In this case, enter the same password twice.

For Netscape Navigator

- When a moving image from VN-C10 is displayed, the page content cannot be updated by changing the window size. In this case, click the [Update] button on the Netscape window to update the page display.

Operations (Step 6 Operations with a Web Browser)

6-2 Access Authorization

The structure of URLs within the VN-C10 is as shown below.

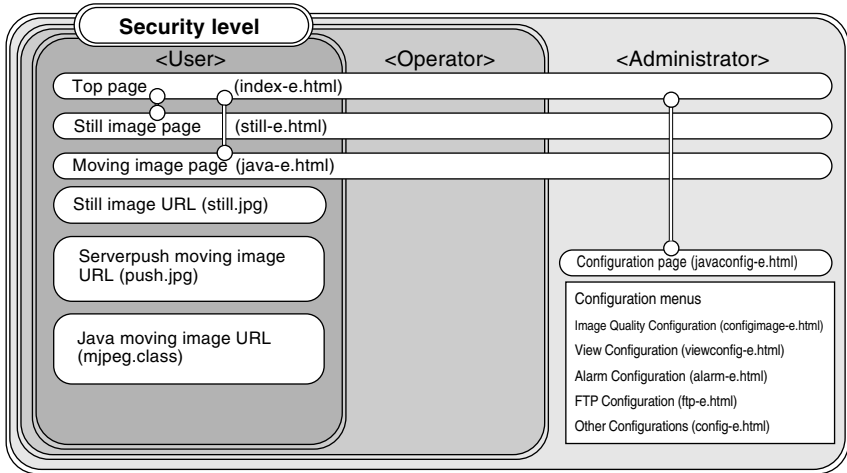

Top page: http://*****/index-e.html (***** represents the URL of VN-C10.)
This page is intended for linkages to other VN-C10 web pages.

Verifying access authorization

If passwords are set, the [User Name and Password] request window appears (for access authorization).

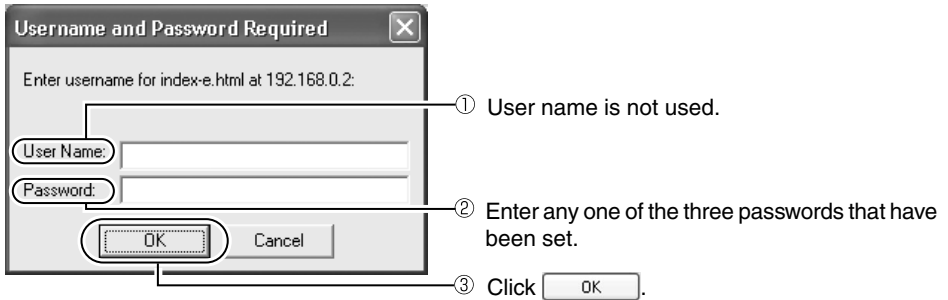

Note

- It is recommended that you register the URL (Uniform Resource Locator).
- For speedy display of the VN-C10 web pages on your web browser, it is recommended that you register the URL information during the access test using the set IP address or DNS host name.
- For this purpose, use the [Favorites] function of Internet Explorer or, in the case of Netscape, [Bookmarks]. While the VN-C10 web page is displayed in the browser, use the [Add] function to bookmark the page.

6-3 Starting Up the Web Browser

Start up the web browser. Specify the factory-set web page address of VN-C10. (With the factory-set IP address entered, the web browser displays the VN-C10 top page.)

Note

If a proxy server is set for accessing the Internet, there are cases in which the IP address cannot be directly specified. In this case, change the proxy setting so that the address can be entered.

1. Start up the Web browser.

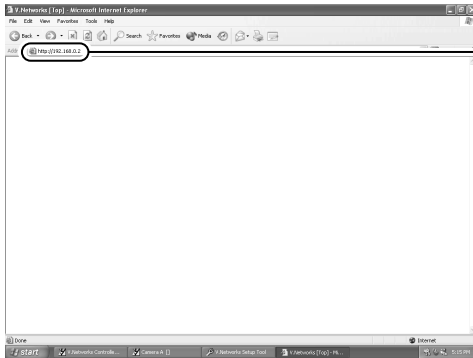

http://192.168.0.2/index-e.html

Note

In this instruction manual, the [Top page] and the [Home page] are defined as follows:

Top page : The "/index-e.html" page

Home page : The specified page displayed when the default page function is enabled. When the function is not enabled, the [Top page] is displayed.

2. The VN-C10 top page appears.

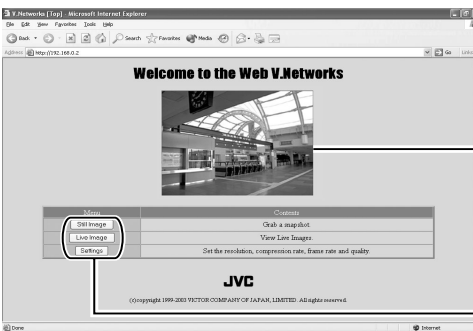

VN-C10 still image

The image taken in at the point when browsing starts is displayed.

Buttons linking to other web pages.
(Click to jump to these pages.)

Caution

If the image mode of VN-C10 is MPEG4, the blue screen appears.

Operations (Step 6 Operations with a Web Browser)

6-4 Settings with a Web Browser

IP address, image quality, alarm, FTP, etc. can be set with a Web browser.

Top page



Click [Settings].

The setting page is displayed.

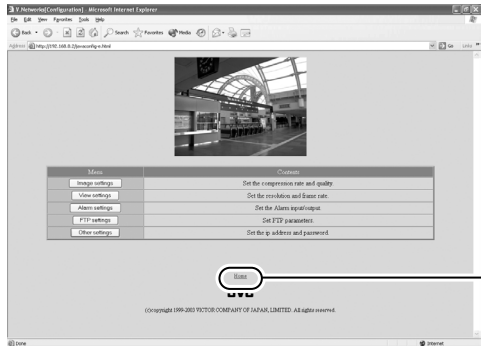

Hyperlink to the Home page.

6-4 Settings with a Web Browser (1. Other Settings)

Other Settings:

http://*****/config-e.html (***** represents the URL of VN-C10.)

The settings can be changed in the [Other] screen.

(They can also be changed with [V.Networks Setup Tool] .)

Other	Settings
DHCP	<input type="radio"/> Available <input type="radio"/> Not available
IP Address	192.168.0.2
Subnet Mask	255.255.255.0
Default Gateway	0.0.0.0
Host Name	<input type="text"/> within 8 characters
MAC Address	00.80.88.00.30.3A
Program Version	Version 1.4
Password (within 8 characters)	User Level <input type="text"/> (confirm)
	Operator Level <input type="text"/> (confirm)
	Administrator Level <input type="text"/> (confirm)
Cache Control	<input type="checkbox"/> No Cache
FTP Server Function	<input type="radio"/> Available <input checked="" type="radio"/> Not available
Default Page	<input type="radio"/> Available <input type="radio"/> Not available
	/user/1.html within 20 characters
HTTP Port	0000 (Normally Port 80)
NTP settings	<input type="radio"/> Available <input type="radio"/> Not available
	Server IP Address <input type="text"/> 0.0.0.0
	Timezone GMT 000 (-12 - +13)
Adjust interval	Adjust in every 00 day 00 hour (within 31 days)

Click "Apply" button to enable the above settings.

Click [Apply] to update the settings.

Operations (Step 6 Operations with a Web Browser)

6-4 Settings with a Web Browser (1. Other Settings) (continued)

Items in the [Other] screen

Item	Effect
DHCP	Sets whether to use DHCP.
IP Address	Changes to the address allotted or approved by the network administrator. (This can be changed only when DHCP is not used.)
Subnet Mask	Sets the value provided or approved by the network administrator as in the case of IP address. (This can be changed only when DHCP is not used.)
Default Gateway	Specifies the IP address for the default gateway. If the default gateway is not to be used, enter "0.0.0.0" here. (This can be changed only when DHCP is not used.)
Host Name	Maximum 8 alphanumerical characters can be entered. Specify the host name when access link is established by a host name in a DNS (Domain Name System) environment. The host name is displayed on the title bar of each sub window. Leave this field blank if the host name is unknown or unnecessary.
MAC Address	Unique physical address of the unit. Cannot be changed.
Program Version	The firmware version of VN-C10. Cannot be changed.
Password	Passwords for accessing VN-C10. Maximum 8 characters.
User Level	Enter the user password.
Operator Level	Enter the operator password.
Administrator Level	Enter the administrator password.
Cache Control	There are a few types of proxy server that caches CGI. With a proxy server of this type, select [No Cache].
FTP Server Function	Select whether to enable or disable the FTP server function. With this function enabled, user html pages, gif images, jpeg images, etc. can be uploaded to VN-C10 using general FTP client software. All uploaded files are stored directly under the [user] folder. It can be accessed as in http://192.168.0.2/user/aaa.html with a Web browser. ("192.168.0.2" denotes the VN-C10 IP address when "aaa.html" stored in the FTP server is referred to.) The FTP server name is fixed to [Administrator]. Use the administrator password.
Default Page	The VN-C10 top page is specified as the default page. If this function is enabled, the specified html file is used as the default page. The default page is the one displayed when only IP address is specified. <div style="border: 1px solid black; border-radius: 15px; padding: 10px; margin-top: 10px;"><p style="text-align: center;">Note</p><p>Even with this function enabled, if the specified html file does not exist, the message, "404: Not found" is displayed when http://192.168.0.2/ is accessed. Ensure that the appropriate file name is entered.</p></div>

6-4 Settings with a Web Browser (1. Other Settings) (continued)

Item	Effect
Default Page (continued)	
Available/ Not available	Select [Available] to enable the Default Page function or [Not Available] to disable it.
File Name	Enter the file name to be used as the default page.
HTTP Port	It is possible to enhance the security level by setting the HTTP server port number to other than the default value "80." (Value range: (1 through 65535 excluding 21 and 554) The new HTTP port number can be accessed with a Web browser. If the port number is changed to, for example, "12345," it can be accessed as http://192.168.0.2:12345 or http://192.168.0.2:12345/indexe.html. If the HTTP port number is unknown, refer to [V.Networks Setup Tool].
NTP Settings	
Available/ Not available	For settings of the NTP (Network Time Protocol) server. Select [Available] to enable the NTP server function or [Not Available] to disable it.
Server IP Address	Enter the NTP server IP address.
Timezone	Obtains the local time based on the Greenwich Mean Time.
Adjust Interval	Rectifies time deviation by acquiring the correct time from the NTP server at a specified interval.

Note

- Password Protection Function

VN-C10 is equipped with a security function for restricting browser (user) access. For this function, there are three access (security) levels according to the authorization status. The table below shows the accessible pages for each status.

(For the VN-C10 Web page structure, refer to page 62.)

Authorization Status	Accessible VN-C10 Pages
User	Still image and moving image pages
Operator	Web pages except the setting pages
Administrator	All Web pages

Caution

- Password setting cannot be released or changed unless the administrator password is entered correctly. Do not forget the administrator password.
- Password entry is not required if the user and operator passwords are set, but not the one for the administrator. The confirmation message, "Are you sure to RESET the camera to enable the changes?" appears. Pressing [OK] for this message prompts VN-C10 to activate its internal reset function, changing the IP address, etc. The previous, factory-set, IP address is no longer in effect, and connection to VN-C10 will be cut off. If there is no keystroke or mouse movement to the Web browser for a while, a message saying that connection cannot be established appears. This is due to the IP address change. (Changing the port number results in the same action.)

Operations (Step 6 Operations with a Web Browser)

6-4 Settings with a Web Browser (2. Image Settings)

Image Quality Setting Window:

http://*****/configimage-e.html (***** represents the URL of VN-C10.)

Click [Apply] to update the settings.

The values set in this screen return to the ones set at the factory.

Item	Effect
Compression Rate	Sets the compression rate for images. A smaller rate means better image quality, but with more amount of data. (Value Range: 1 to 7) (Factory-set value: 2)
Saturation	Adjusts color saturation. A smaller value makes colors less dense. (Factory-set value: 25)
White Balance	Color correction system to deal with different lighting conditions.
Auto	Automatically adjusts the white balance, the standard for color saturation.
R gain	To manually adjust the white balance toward more red intensity. (Value range: 0 to 100) (Factory-set: Auto)
B gain	To manually adjust the white balance toward more blue intensity. (Value range: 0 to 100) (Factory-set: Auto)
AGC, AES, BLC	AGC : Automatically adjusts the gain in accordance with the brightness. Factory set. AES : Automatically adjusts the shutter speed in accordance with the brightness. Only for a manual iris lens. BLC : Back light compensation. When there is a bright light source in the background of the object, VN-C10 adjusts the weighted zone.
Shutter Speed	1/60 : Normal factory set speed. 1/100 : This reduces image flickers due to fluorescent lighting in areas where the commercial power frequency is 50 Hz. (Factory-set value: 1/60)
Iris level	Brightness adjustment for a DC IRIS lens. A smaller value makes images darker, closing the iris.

6-4 Settings with a Web Browser (3. View Settings)

View Setting Window:

http://*****/viewconfig-e.html (***** represents the URL of VN-C10.)

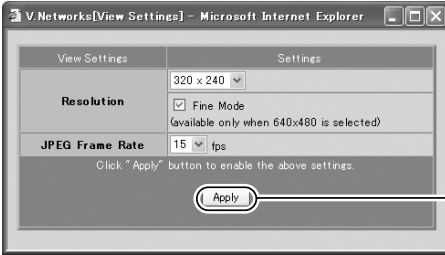

Click [Apply] to update the settings.

Item	Effect
Image size	Select one from the 3 image sizes, “640x480,” “320x240” or “160x120.” ※ In the Fine mode, image details can be checked. Do not use the Fine mode when a moving object is to be recorded.
JPEG frame rate	Select the maximum number of frames to be transmitted from VN-C10 per second.

Caution

- The actual number of frames transmitted and displayed per second is dependent on factors such as PC performance, Web browser or LAN environment, etc. In cases where operation of VN-C10 can be expected to cause communication trouble to other network operations (particularly when the network traffic is usually heavy), it is recommended to reduce the frame rate.
- Be sure to adjust the frame rate appropriately considering the number of simultaneous accesses to VN-C10. If VN-C10 is operated beyond its processing capacity, functions such as Web page display, image shifting and button selection may not work properly.

Operations (Step 6 Operations with a Web Browser)

6-4 Settings with a Web Browser (4. Alarm Settings)

Alarm Setting Window:

http://*****/alarm-e.html (***** represents the URL of VN-C10.)

This section describes the setting of actions of VN-C10 when an alarm signal has been received.

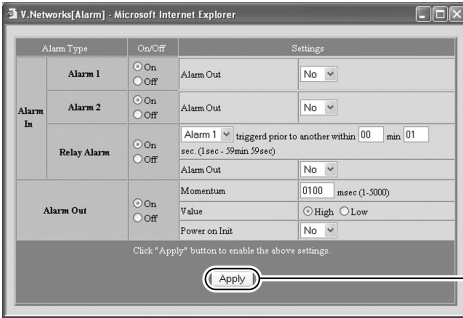

Click [Apply] to update the settings.

Item	Effect
Alarm In	Specifies the action when an alarm signal has been received.
Alarm 1 and 2	Specifies the action when an alarm signal has been input to [Alarm 1] and/or [Alarm 2].
On/Off	Select [On] if the alarm terminals [Alarm 1] and/or [Alarm 2] are to be used. If not to be used, select [Off].
Alarm Out	If [On] is selected here, alarm signals are output to the [ALARM OUTPUT] terminal located on the rear panel.
Relay Alarm	Sets the relay alarm function, which is activated when two alarms are successively received within a certain period of time.
On/Off	Select whether to enable or disable the relay alarm function.
Relay Alarm Setting	Sets the sequence and interval of alarm input.
Alarm Out	If [On] is selected here, alarm signals are output to the [ALARM OUTPUT] terminal located on the rear panel.
Alarm Out	
On/Off	Select [On] for alarm signals to be output to the [ALARM OUTPUT] terminal located on the rear panel.
Momentum	Sets the duration for sending alarm output signals.
Value	Sets whether to output high or low signals for alarm output.
Power on Init	If [Yes] is selected, the alarm signal, which was set upon power connection, is output once.

Caution

- Perform the output setting appropriately according to the equipment to which signals are sent.
- When the alarm setting is complete, check whether the alarm functions are working properly.

6-4 Settings with a Web Browser (5. FTP Settings)

FTP Client Setting Window:

http://*****/ftp-e.html (*****/ represents the URL of VN-C10.)

(This function cannot be set for MPEG4.)

Note

- FTP Client Function

This is a function that regularly uploads VN-C10 still images to the existing FTP server.

With this function, it is possible to distribute images from the server, thus greatly increasing the number of clients, which receive them.

FTP	Settings
	<input checked="" type="checkbox"/> Snap Shot FTP
	Upload Interval 00060 sec (0-86400 sec)
FTP Function	Filename <input type="radio"/> vnetworks.jpg (1-32 characters) <input type="radio"/> Timestamp (ex.2001-06-07-17-34-12-653.jpg)
Username	anonymous (1-16 characters)
Password	(0-32 characters)
Host IP Address	0.0.0.0
FTP Port	00021 (Normally Port 21)
FTP Folder	(0-64 characters)
Connection	<input type="checkbox"/> disconnect every time
Error Recovery	On connect error <input type="radio"/> Retry forever
	<input type="radio"/> Retry for 010 min (1-600 min)
	On transfer error <input checked="" type="checkbox"/> Stop Uploading
Click "Apply" Button to enable the above settings.	
<input type="button" value="Apply"/>	

Click [Apply] to update the settings.

Operations (Step 6 Operations with a Web Browser)

6-4 Settings with a Web Browser (5. FTP Settings) (Continued)

Item	Effect
FTP Function	For enabling/disabling the FTP functions.
Snap Shot FTP	Select here if JPEG images are to be uploaded to an FTP server regularly.
Upload Interval	Specify the interval with which images are uploaded to an FTP server. (0 to 84600 seconds)
File name	Specify the file name of an image to be uploaded.
*.jpg	Uploading is performed with the file name entered here. * Only one image file remains in the FTP server as files have the same file name. (The latest image file overwrites.)
Time Stamp	The current time, obtained from the NTP server, is used as the file name for uploading in the form of “YYYY-MM-DD-HH-MM-SS-mmm”. * As each file has a unique name for uploading, all image files uploaded remain in the FTP server.
Username	Enter the user name (up to 16 characters) to be used for verification with the FTP server.
Password	Enter the password (0 to 32 characters, shown as asterisks “*”) to be used for verification with the FTP server.
Host IP Address	Enter the IP address of the FTP server to which images are uploaded.
FTP Port	Enter the port number of the FTP server to which images are uploaded.
FTP Folder	Enter the folder name in the FTP server to which images are uploaded.
Connection	Set whether to cut off the connection during every upload.
Disconnect every time	If this is selected, connection is cut off every time an image has been uploaded. Connection will be reestablished when the next image is uploaded.
Error Recovery	Specify the action to be taken when an FTP error has occurred.
On connect error	Specify the action to be taken when an error with TCP connection or FTP verification has occurred.
Retry forever	Error recovery is attempted until the power to VN-C10 is disconnected.
Retry for * min	Error recovery is attempted for a specified period of time. (1 to 600 minutes)
On transfer error	Specify the action to be taken when a file transfer error has occurred during image uploading.
Stop Uploading	With the occurrence of a transfer error, the VN-C10 FTP function is automatically disabled. Select here to enable the function again.

6-5 Viewing Still Images

Still Image Page:

http://*****/still-e.html (*****/represents the URL of VN-C10.)

This page displays only still images. The initial image is the one taken in by the camera at the moment browsing starts. To update the image, press [Refresh] or [Reload] depending on the Web browser and to save the displayed image, select [Save As].

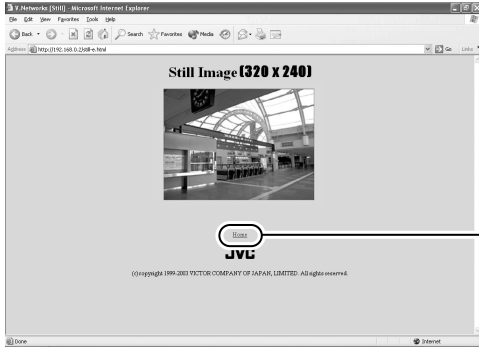

Hyperlink to the Home page

Operations (Step 6 Operations with a Web Browser)

6-6 Viewing Moving Images

Moving Image Page:

http://*****/java-e.html (*****/ represents the URL of VN-C10.)

This page displays only moving images. The images taken in by the camera are updated automatically and displayed as moving images.

Note

- Moving image pages cannot be saved using the [Save Image As] function of the Web browser.
- Web pages cannot be saved using the [Save As] function.

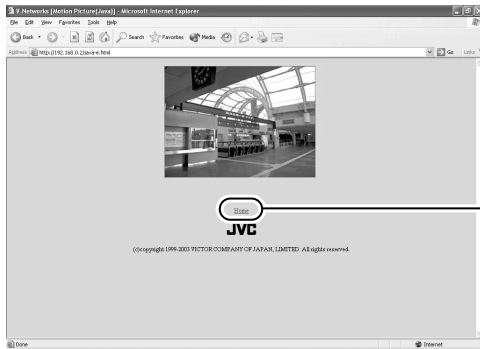

Hyperlink to the top page

6-7 VN-C10 Image Link

VN-C10 output images can be pasted onto separately created web pages – Images (still and moving) captured with VN-C10 can be incorporated and displayed on a user-created web page.

Note

Images cannot be displayed when VN-C10 is in the MPEG4 mode.

Displaying a Still Image:

By creating a web page with the following description, you can display a still image.

```
<IMG SRC="http:// ***** /still.jpg"> ( ***** represents the URL of VN-C10.)
```

Displaying a Moving Image:

A moving image can either be in the Serverpush or Java format.

It is necessary to choose the image type or adjust the content description of the web page according to its compatibility with the web browser in use.

Display in Serverpush

By creating a web page with the following description, you can display a moving image in Netscape Navigator that supports Serverpush.

```
<IMG SRC="http:// ***** /push.jpg"> ( ***** represents the URL of VN-C10.)
```

Display in Java Applet

By creating a web page with the following description, you can display a moving image (Java applet) in Internet Explorer, etc. that supports Java.

```
<APPLET CODE="mjpeg.class" WIDTH=640 HEIGHT=480  
CodeBase="http:// ***** /"> </APPLET> ( ***** represents the URL of VN-C10.)
```

Note

- The images (both still and moving) are displayed according to the size and compression rate already set. If Java is disabled in the Web browser, images may not be displayed correctly.
- If a password has been set, prior password authentication is necessary before Java Applet can be displayed (an Internet Explorer restriction).
- The values of "WIDTH" and "HEIGHT" should be identical to those of the image size setting of VN-C10.
- If the browser version used is older than Netscape Ver. 4.06, it is required to update the Java Plug-in version to 1.1 or higher in order to browse moving images. Java Plug-in is available in Web sites such as "http://java.sun.com/getjava/" etc.

Others

Troubleshooting

Symptoms	Remedial Actions
Forgotten the VN-C10 IP address that was changed with [V.Networks Setup Tool].	<ul style="list-style-type: none">• Press the [Search] button of [V.Networks Setup Tool] to see the IP addresses of all the cameras connected to the network.
Unable to record.	<ul style="list-style-type: none">• Has the folder for saving images been deleted? Check to see if it exists.• Is the disk full? Check the available memory capacity.
While “Now Connecting...” is being displayed, it takes time to cancel an action.	<ul style="list-style-type: none">• Once connection is activated, canceling an action is not possible.
The coloration is unsatisfactory.	<ul style="list-style-type: none">• Check the color adjustments of the monitor and video cards. Change to the True Color (24 bits) display.• With High Color (16 bits) or lower, display of natural color tones is difficult to achieve.
Image size changes automatically.	<ul style="list-style-type: none">• In the case that VN-C10 is connected to multiple PCs, VN-C10 assumes the settings of the PC that was last operated.
Connection to VN-C10 cannot be established or fails.	<ul style="list-style-type: none">• When the network is loaded with frequent broadcasting or collisions, connection may fail or break. Check the network status.

Others

Specifications

LAN standard	IEEE802.3, IEEE802.3u
Communication protocol	TCP/IP, UDP, HTTP, FTP, ICMP, ARP, RTP, RTSP, DHCP, NTP
Image pickup device	1/3 type IT CCD
Available pixels	Approx. 380,000 pixels (768 (H) x 494 (V))
Video S/N ratio	50 dB (50 %, AGC OFF, Compression rate: 1)
Minimum required illumination	2.5 lx (50 %, F1.2, AGC ON)
Image compression	JPEG, MPEG4
Output image format	640 x 480, 320 x 240, 160 x 120 640 x 480 not available for MPEG4
Lens mount	C/CS mount
Alarm input	Non-voltage "A" contact input. NPN open collector input. Low level, latch/momentary (500 ms minimum) Low level circuit current: 0.6 mA High level impressed voltage: 3.3 V
Alarm output	NPN open collector output (allowable impressed voltage: 12 V, allowable input current: 300 mA)
Network interfaces	RJ-45 (Category 5) 10BASE-T/100BASE-TX (Auto-Negotiation)
Internal memory	8 MB
Power supply voltage	DC 12 V or AC 24 V, 50 Hz/60 Hz
Power consumption	1.2 A max.
Operating temperature	0 °C to 40 °C
Mass	Approx. 560 g

External Dimensions

(Unit: mm)

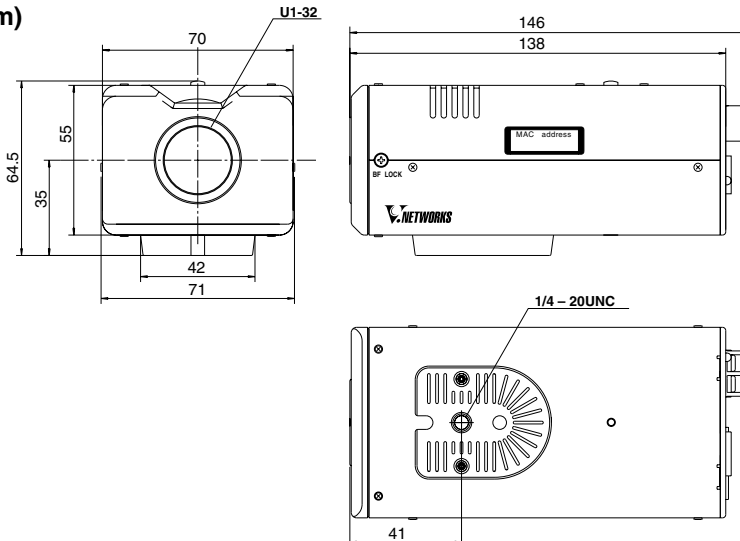

● Design and specifications are subject to change without notice.

VN-C10

V.NETWORKS

JVC®

VICTOR COMPANY OF JAPAN, LIMITED

JVC® is a registered trademark owned by VICTOR COMPANY OF JAPAN, LTD.

JVC® is a registered trademark in Japan, the U.S.A., the U.K. and many other countries.

© 2003 VICTOR COMPANY OF JAPAN, LIMITED



Printed in Japan

LWT0095-001C